

MULTIFLEX

The flexible girder slab formwork for all ground plans and slab thicknesses up to 1.00 m

Product Brochure – Issue 08/2018

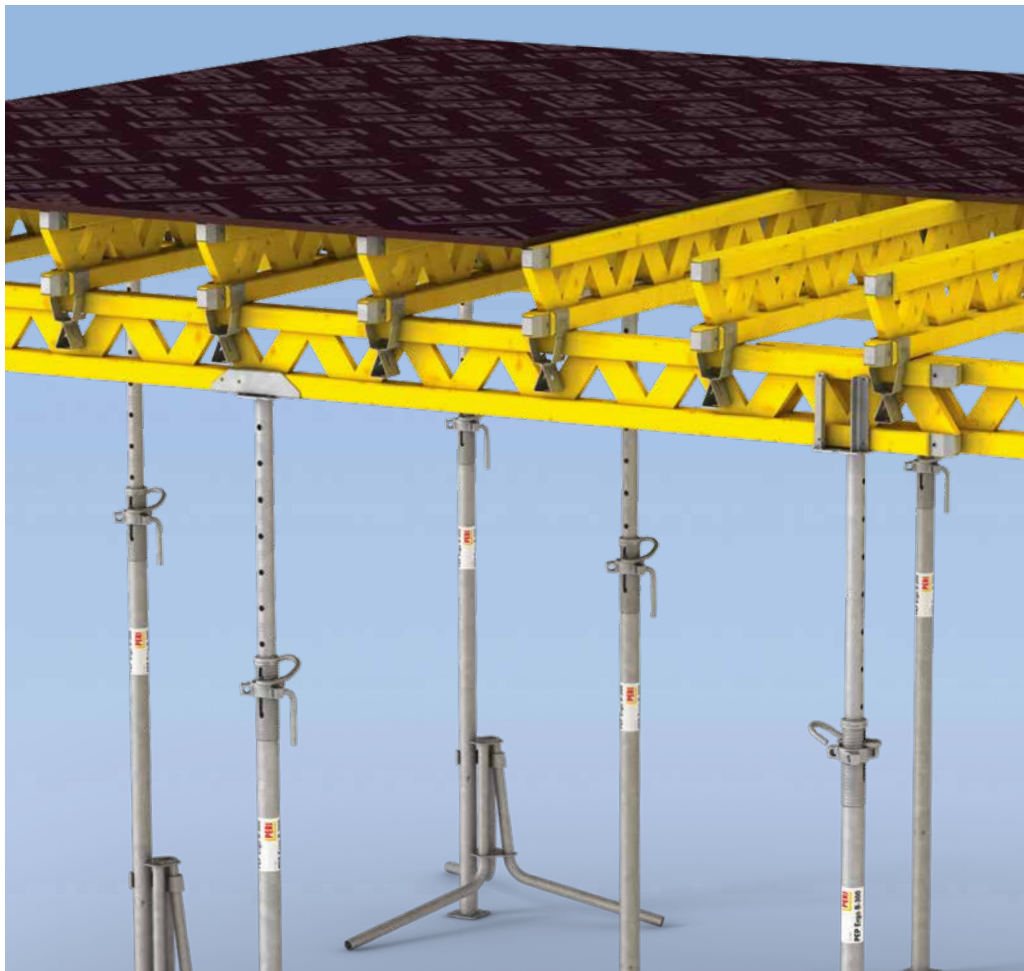

Content

System advantages of the MULTIFLEX

- 3 The flexible girder slab formwork for every ground plan and slab thicknesses up to 1.00 m
- 4 Optimized use of materials
- 6 For all ground plans
- 7 For all surface requirements
- 8 Design example of MULTIFLEX Slab Formwork

System overview

- 10 MULTIFLEX at a glance

Standard applications

- 12 Load transfer with MULTIFLEX
- 14 Detailed solutions for stopend formwork
- 16 Detailed solutions for beams

System supplements

- 17 Fast and safe working with MULTIFLEX

Issue 08/2018

Publisher

PERI AG Formwork Scaffolding Engineering

Rudolf-Diesel-Straße 19
89264 Weissenhorn
Germany
Phone +49 (0)7309.950-0
Fax +49 (0)7309.951-0
info@peri.com
www.peri.com

Project examples
20 The MULTIFLEX Girder
Slab Formwork in use

Important notes

Without exception, all relevant safety regulations and guidelines must be observed at all times in those countries where our products are used.

The photos shown in this brochure feature construction sites in progress. For this reason, safety and anchor details in particular cannot always be considered as conclusive or final. These are subject to the risk assessment carried out by the contractor.

In addition, computer graphics are used which are to be understood as system representations. For ensuring a better understanding, these and the

detailed illustrations shown have been partially reduced to certain aspects. The safety installations which have possibly not been shown in these detailed descriptions must nevertheless be available. The systems or items shown might not be available in every country.

Safety instructions and load specifications are to be strictly observed at all times. Changes and deviations always require separate static proof.

The information contained herein is subject to technical changes in the interests of progress. Errors and typographical mistakes reserved.



Peace Coliseum, Overstock.com Corporate Campus,
Salt Lake City, UT, USA

MULTIFLEX

The flexible girder slab formwork for all ground plans and slab thicknesses up to 1.00 m

With MULTIFLEX, every slab thickness, any ground plan and all floor heights can be formed. Main components of the MULTIFLEX are the VT 20K or GT 24 Formwork Girders. The possible combinations of these formwork girders ensure the highest level of flexibility for adapting to project-specific requirements.

Main and cross beams, their position and spacing, as well as formlining along with the shoring are freely selectable. As a result, MULTIFLEX Slab Formwork can be ideally adapted to suit every ground plan and all loads. If the high

load-bearing GT 24 Formwork Girders are used, large spans for the main and cross beams can be realized.

The overlapping of the slab girders and variable positioning of the main beams ensure maximum flexibility. MULTIFLEX is therefore the ideal solution for simple and complicated ground plans, slabs with offset outer edges or integrated downstanding beams, as well as forming operations in confined spaces.

Depending on the load and height of the room, PERI steel tube or aluminium slab props, shoring towers or PERI

UP Flex modular scaffolding is used as shoring. For this, lowering heads, cross heads and claws heads are available which can be combined with the PERI shoring.

Optimized use of materials

through any combination of GT 24 and VT 20K Formwork Girders as well as a freely selectable girder arrangement

For all ground plans

through the variable positioning of the girders – also polygonally, trapezoidal or overlapping

For all surface requirements

easily adaptable with freely selectable formlining according to the required quality of the slab underside

Optimized use of materials

Any combination of formwork girders and freely selectable girder arrangement

The formwork girders as well as the respective spacings are selected according to project-specific requirements. Thus, MULTIFLEX stands for cost-effective working operations for every ground plan.

The slab formwork can be realized with different combinations of main and cross beams. Depending on the span and loads, the VT 20K Formwork Girder, the high load-bearing GT 24 or a combination of both are used.

The VT 20K Solid Web Girder is the cost-effective solution for smaller slab thicknesses. The girder with a 20 cm overall height was specially developed for slab formwork operations.

The GT 24 Formwork Girder with a 24 cm overall height offers considerably more load-bearing capacity and higher bending stiffness. As a result, larger spans for example are possible. This reduces material usage as well as workload.



For applications with the GT 24, fewer girders, steel waling or slab props are required. This results in savings in both material and labour costs.

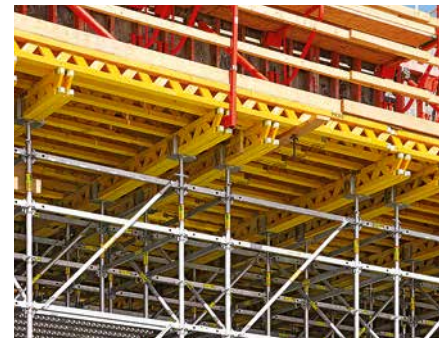

The use of the load-bearing GT 24 Girder as a double main beam in connection with PERI UP Rosette Flex shoring, facilitates the transfer of heavy loads over great heights.

Technical data (see Design Tables)

- GT 24 as main beam and cross beam: slab thicknesses up to 1.00 m
- VT 20 as main beam and cross beam: slab thicknesses up to 1.00 m
- GT 24 as double main beams and GT 24 as cross beam: slab thicknesses up to 1.00 m
- VT 20 as double main beam and VT 20 as cross beam: slab thicknesses up to 1.00 m

VT 20K**The cost-effective solid web girder**

The girder with a 20 cm overall height was specially developed for slab formwork operations. It can be used as a cross and main beam.

The PERI VT 20K is the economical, 20 cm high solid web girder. Robust steel caps on the ends of the chords along with the concave web end provide the girder with reliable protection against damage. The 8 cm wide chords also provide sufficient width for plywood joints.

- Universal solid web girder made of wood with a 20 cm overall height
- 11 lengths from 1.45 m to 5.90 m
- Weight: 5.30 kg / m (production weight)
- Permissible bearing force: 11.00 kN
- Permissible bending moment: 5.00 kNm
- Bending stiffness: $EI = 460 \text{ kNm}^2$

GT 24**The versatile lattice girder with a high load-bearing capacity**

The girder nodes with mini-dovetail jointing ensures the stability of the GT24 Formwork Girder through a special node design in the timber chord.

Through the lattice construction and 24 cm overall height, the GT 24 Formwork Girder provides a high load-bearing capacity and rigidity. Due to the sturdy design and girder nodes with mini-dovetail jointing, the formwork girder is extremely robust. The design simplifies the assembly of accessories.

- Universal formwork girder made of wood with a 24 cm overall height
- 18 lengths from 0.90 m to 6.00 m in 30 cm increments, extra-long up to 17.85 m on request
- Weight: 5.90 kg / m
- Permissible bearing force: 28.00 kN
- Permissible bending moment 7.0 kNm
- Bending stiffness: $EI = 887 \text{ kNm}^2$

For all ground plans

Variable positioning of the girders – also polygonally, trapezoidal or overlapping

Through the possibility of changing the main beam direction, the variable alignment and the overlapping of the girders allows the MULTIFLEX to be easily adapted to accommodate a broad range of ground plans.

Due to the fact that the position, alignment and the spacing of the main and cross beams can be freely selected, MULTIFLEX Slab Formwork can also be adapted to suit complicated ground plans. In addition, circular slab areas can be formed with MULTIFLEX whereby the girders are simply arranged radially.

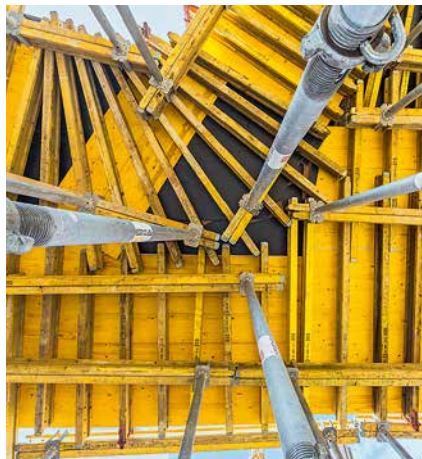

For all surface requirements

Freely selectable formlining in accordance with the required quality of the slab soffit



MULTIFLEX can be used with any type of formlining. Depending on the requirements regarding frequency of use and the slab soffit in particular, formlining sheets of various qualities and dimensions can be installed on the formwork girders.

Depending on the required quality of the slab soffit, the most appropriate formlining can always be used which also takes the corresponding joint arrangement into consideration. Through project-related customized formlining sheets and special sizes, filler areas can be completely closed.

For this underground roundabout, MULTIFLEX formed an even intermediate platform which covered the entire area. As formlining, 3-Ply plywood with 0.50 m widths was used. With this formliner, the concrete finish features a wood texture.

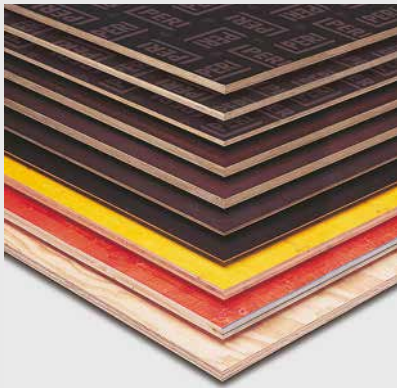

Examples taken from the PERI plywood panel portfolio

- **PERI FinPly | PERI FinPly Maxi | PERI RusPly**
Coated plywood for very high specifications and demanding concrete surfaces; made of cross-bonded birch veneers with reinforced phenolic resin on both sides
- **PERI Spruce**
Coated plywood for a smooth concrete finish with a slightly textured surface; 7-veneer construction made of Nordic softwood, with phenolic resin on both sides
- **3-Ply Plywood**
Large sheets of plywood for concrete surfaces with high specifications and a concrete finish with a slight timber structure
- **PERI FinNaPly**
Shuttering plywood for concrete surfaces with a timber structure



PERI release agent

PERI release agent is a fluid, chemical-physical concrete release agent for all commercially available formwork and construction equipment.

- **PERI Clean and PERI Bio Clean**
used for absorbant as well as non-absorbant formlining sheets (e.g. boards, coated large-sized plywood sheets, steel)
- **PERI Plasto Clean**
is biodegradable in accordance with OECD Guideline 301c; PERI Plasto has been specially developed for formlining with plastic surfaces

Design example of MULTIFLEX Slab Formwork

Optimized use of individual components

With the PERI Design Tables, MULTIFLEX Slab Formwork is quickly and easily planned.

The possible cross beam spacing is determined via the slab thickness while taking into account the form-lining (3-Ply plywood, 21 mm). The pre-selection of the permissible prop spacing, possible main beam spacing and actual prop load allows the user to optimally plan and use MULTIFLEX – depending on the available girder lengths, prop load-bearing capacity and geometry of the building.

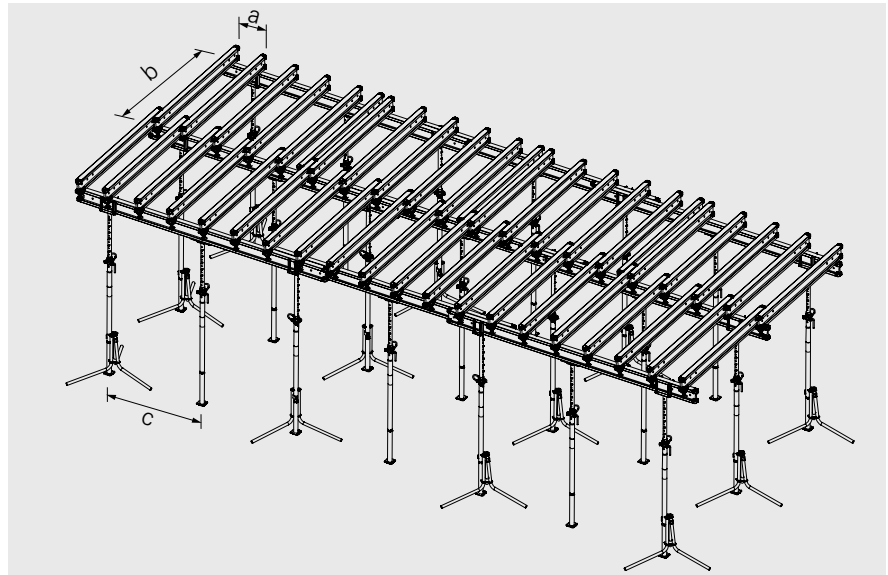

With the MULTIFLEX configurator, the user can quickly and easily optimize the girder/prop spacings as well as the props.

Underlying standard

The load assumption is calculated according to DIN EN 12812-2008-12 with a bulk density of the fresh concrete of $\gamma = 24.5 \text{ kN/m}^3$ ($g = 9.81 \text{ m/s}^2$).

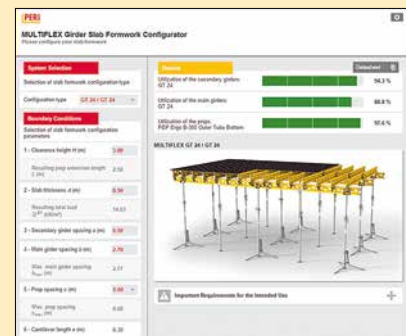

Functional description (web app)

Firstly, the user selects the required assembly version whereby 5 girder combinations are possible. After entering the clear room height, slab thickness and cross beam spacing, the MULTIFLEX configurator determines the maximum possible main beam spacing.

After selecting and entering the main beam spacing, the app determines the maximum prop spacing. Using the given clear room height and prop spacing, the cantilever length, resulting prop load and a list of all possible prop types along with their corresponding permissible prop loads are determined. The permissible prop load is determined for the selected prop type. As a result, the utilization rate of the cross beam/main beam are additionally shown.

The PDF output format for the documentation, direct printing or sending via e-mail is provided by the application. The customer's building specifications are integrated via a note in this data sheet.

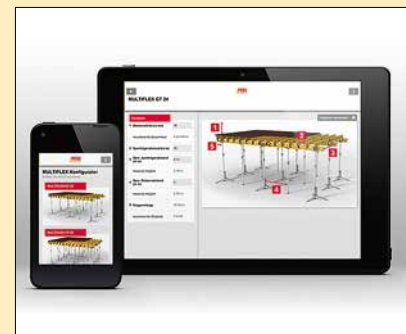

Design example with Table VT 20 / VT 20

Slab thickness	d = 20 cm
Clear room height	h = 2.80 m
Main and cross beam	VT 20
Plywood formlining	21 mm, 62.5 x 250 cm

1. Cross beam spacing a (formlining support)

The cross beam spacing is determined depending on the slab thickness and the size of formwork used or type of formlining.

Selected cross beam spacing a = 62.5 cm

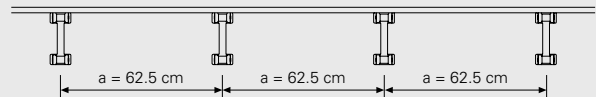

2. Main girder spacing b (cross beam support)

According to the Design Tables, the max. permissible span for the cross beam is 2.05 m. A main beam spacing of 2.00 m is selected (depending on the room geometry).

Selected main beam spacing b = 2.00 m

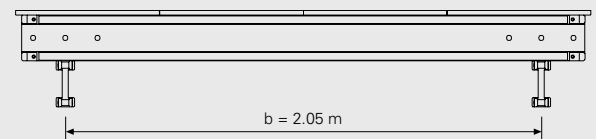

3. Prop spacing c (main beam support)

Selected prop spacing c = 1.50 m

4. Prop load F_v (Determining the load to be accommodated)

In accordance with the PERI Design Tables, the load is 22 kN with a main beam spacing of 2.00 m. Through the selected smaller main beam spacing of $b = 2.00$ m, this results in the following reduced prop load:

$$F_v = 22 \text{ kN} \times (2.00 \text{ m} / 2.05 \text{ m}) = 21.5 \text{ kN}.$$

Subsequently, a PERI slab prop (PEP; MULTIPROP) is selected which corresponds to the extension length h with permissible prop load = 21.5 kN.

Prop load F_v to be accommodated = 21.5 kN

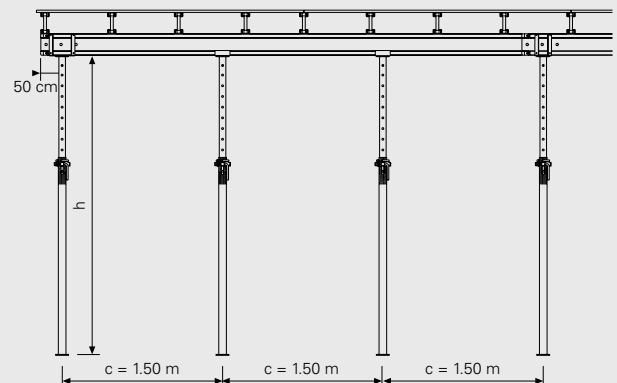

MULTIFLEX at a glance

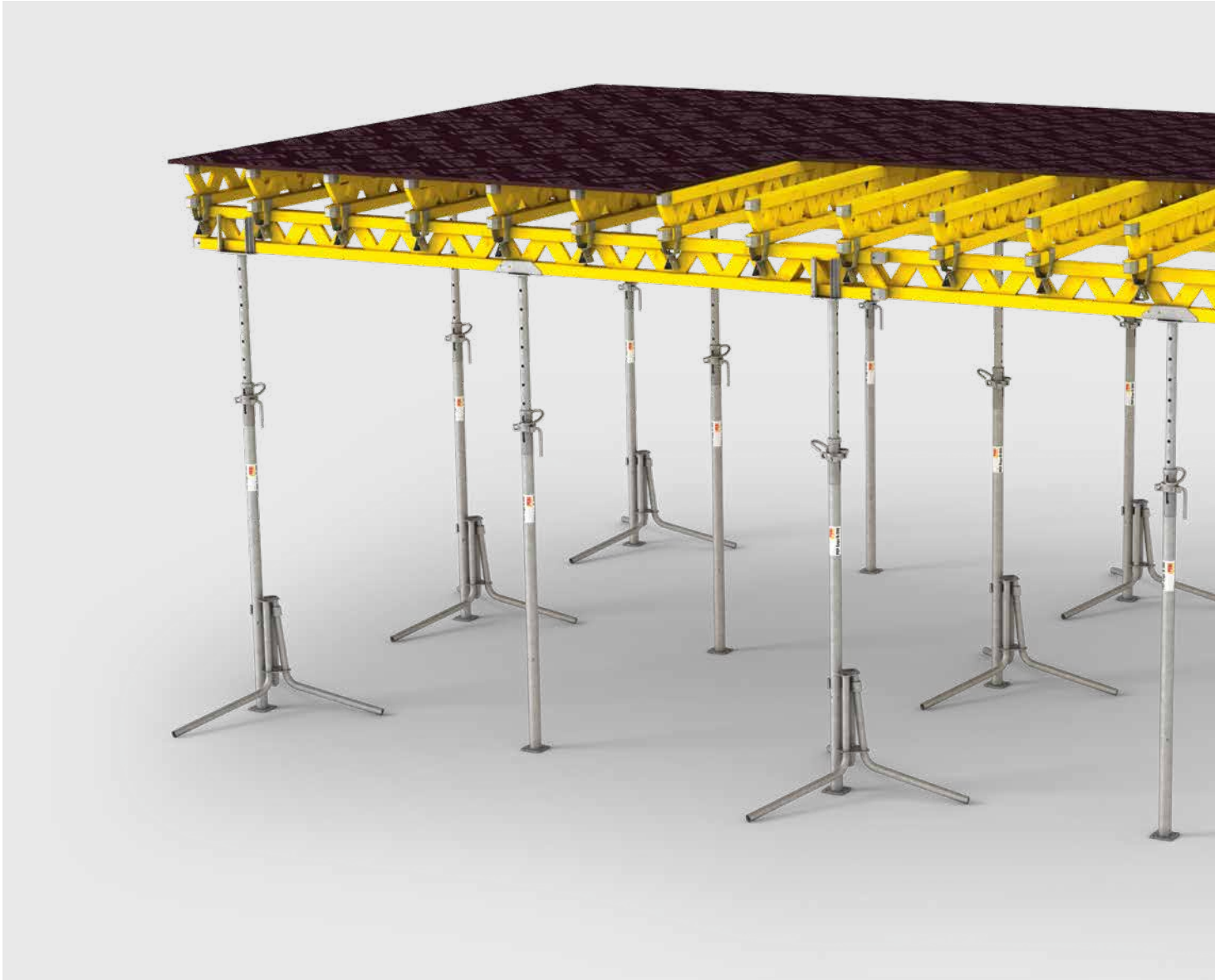



The graphic representation shows the execution with GT 24 Formwork Girders as main and cross beams. Alternatively, VT 20K Formwork Girders can be used, or a combination of both girders. For high loads, assemblies with 2 parallel beams arranged as double main beams are also possible.

GT 24 as main beam and cross beam

Slab thicknesses up to 1.00 m

VT 20 as main beam and cross beam

Slab thicknesses up to 1.00 m

**2 x GT 24 as main beams
1 x GT 24 as cross beam**

Slab thicknesses up to 1.00 m

**2 x VT 20 as main beams
1 x VT 20 as cross beam**

Slab thicknesses up to 1.00 m

Load transfer with MULTIFLEX

Formwork support, slab props and shoring

Loads from the MULTIFLEX Slab Formwork must be safely transferred into the ground. For this, various PERI props and shoring possibilities can be used. System components required for supporting the slab formwork are available for all systems.

Formwork support

For providing stable and tilt-proof support for one or two formwork girders and as intermediate support, a range of heads is available.

On the girder ends as well as girder joints, the Crosshead 20/24S with self-locking coupling or Lowering Head 20/24 with bolt and cotter pin can be used. For intermediate support, the Clawhead 24S or Clawhead 16/20S is utilized – both complete with self-locking couplings.



Lowering Head 20/24

For rigid and tilt-resistant support of one or two GT 24 or VT 20 girders, with a lowering range of 4 cm.



Crossheads 20/24, galv. Crosshead 20/24 S, galv. Crosshead 20/24, galv.

With or without self-locking couplings for stable support of one or two GT 24 or VT 20 girders.



Clawheads 24, galv. Clawhead 24 S, galv. Clawhead 24 L, galv.

With or without self-locking couplings for positioning intermediate props on GT 24 girders without nailing



Clawheads 16/20, galv. Clawhead 16/20 S, galv. Clawhead 16/20, galv.

With or without self-locking couplings for positioning intermediate props on VT 20 girders without nailing

PEP Ergo Slab Props

PEP Ergo props fully comply with Load Class B, D and E of EN 1065. The maximum load-bearing capacity is 50 kN. Thereby, the transfer of loads is also possible when using double main beams even for standard applications with GT 24 Formwork Girders. Hot-dip galvanization of all surfaces ensures a long service life. The low weight whilst maintaining a high load-bearing capacity makes it extremely cost-effective.



PEP Ergo Steel Slab Props are available in the following lengths:
1.50 m, 2.50 m,
3.00 m, 3.50 m,
4.00 m and 5.00 m.

MULTIPROP Slab Props

MULTIPROP props are made of aluminium and therefore relatively lightweight, e.g. the MP 350 with an extended length of up to 3.50 m only weighs 19.40 kg. The props are type tested and carry up to 90 kN - this means they are suitable for accommodating high loads and, due to their length, ideal for larger room heights.

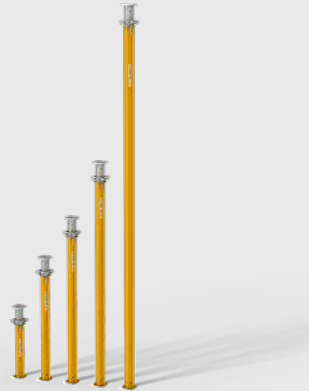

MULTIPROP props are type tested. Available in lengths of 1.20 m, 2.50 m, 3.50 m, 4.80 m and 6,25 m.



The Universal Tripod is used as an erection aid. Horizontal loads have to be transferred through the formwork to the structure.

MULTIPROP Shoring Towers

The MULTIPROP props are supplemented with frames and can also be used as shoring tower. For erection of a tower, MULTIPROP frames are mounted using the captive wedge. Fastening is possible to both the outer and inner tubes. Ingeniously designed details ensure a long service life.



Shoring systems

For larger room heights, ST 100 Stacking Tower or PERI UP Flex Modular Scaffolding provide the ideal support for the MULTIFLEX.



Detailed solutions for stopend formwork

Stopend formwork

Stopend Angle AW

The PERI Stopend Angle AW - the solution for slab edge stopends up to 40 cm thick and max. 60 cm thick beams.

The stopend angle can be nailed on wooden girders or directly on the formlining. The direction of the pre-drilled nail holes thus ensures the maximum load-bearing capacity. Nail holes allow fixing in any direction, on the girder in the longitudinal direction as well as on the formlining transversely to the girder.



Stopend angles made of plastic

The plastic version of the slab stopend angle has a lower load-bearing capacity but, with a weight of less than 500 g, is significantly lighter than a conventional metal angle. It can be combined with VT 20 and GT 24 girders and is suitable for setting of stopends on slab edges as well as the forming of beams up to max. 50 cm thick.



Formwork Bracket-2

For slab cantilevers up to 45 cm with a maximum 30 cm slab thickness. Cantilevers can be adjusted exactly as required by means of the quick jack nut.

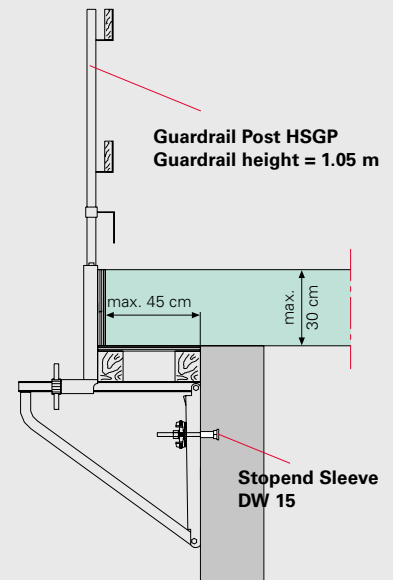
**Slab Stopend Bar 105**

For shuttering of slabs up to 50 cm thick flush with the wall. The Slab Stopend Bar 105 is aligned parallel to the external wall surface by means of the adjustable spindle.

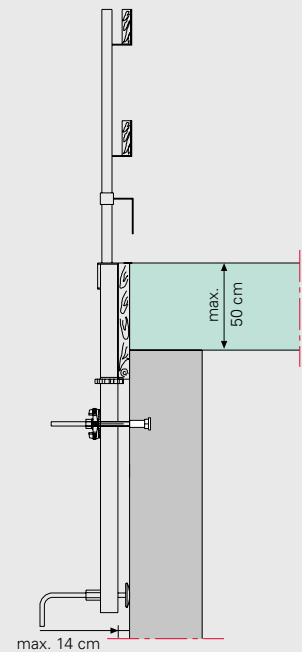

Detailed solutions for beams

Beams

Beam Formwork UZ

The PERI UZ Beam System is the solution for large beam cross-sections. With the Beam Bracket UZ 40 and Perforated Rail UZ, beam heights of up to 80 cm are possible without any ties. For larger heights, one additional tie is necessary at the top. The Perforated Rail UZ connects both beam brackets very tightly.



Max. beam widths with form width $b = 10$ cm

- 1 x UZ Perforated Rail 80 = 45 cm
- 2 x UZ Perforated Rails 80 = 135 cm
- 1 x UZ Perforated Rail 129 = 95 cm

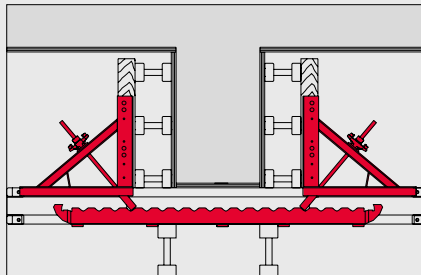

Wall Clamps

Smaller beams can likewise be shuttered with PERI Wall Clamps 55, 75 or 105. Especially practical are the friction-locked fine adjustments with the quick jack nut without wedges along with the self-cleaning, robust square thread on the arm.



Fast and safe working with MULTIFLEX

Tilt prevention with Flexclip

The Flexclip combines cross and main beams and ensures a tilt-proof connection of the girder without nailing. The clip is available in three versions for all girder combinations:

- GT 24 / GT 24
- GT 24 / VT 20
- VT 20 / VT 20



Spacing gauge and fixing tool

MULTIFLEX is formed from the assembly area. The fixing tool – supplemented by the spacing gauge – thereby simplifies the mounting of the cross beams; because the pre-adjusted girder spacing on the spacing gauge makes time-consuming measuring of cross beam spacings unnecessary. Using the same fixing tool, the flexclips are also safely mounted from the ground.



Fast and safe working with MULTIFLEX

Guardrails

Guardrail Holder GT 24 /VT 20 with Guardrail Post HSGP-2 serve for mounting anti-fall protection on GT 24 and VT 20 girders.

Maximum post spacing is

- 1.20 m with Side Mesh Barrier PMB 130
- 2.10 m with guardrail boards
- 2.40 m with Side Mesh Barrier PMB 260

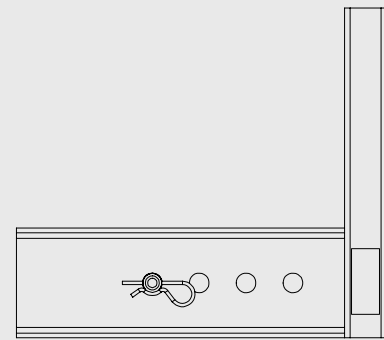
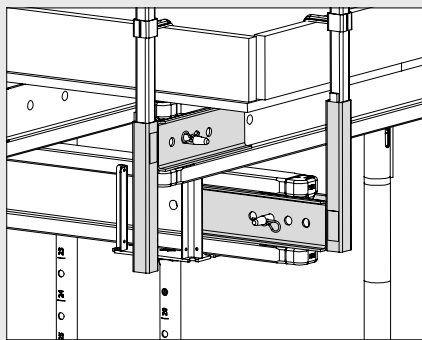

Guardrails on casting segments

The Stopend Angle AW or plastic stopend angle can be used in combination with the Guardrail Post AW for anti-fall protection on casting segments.

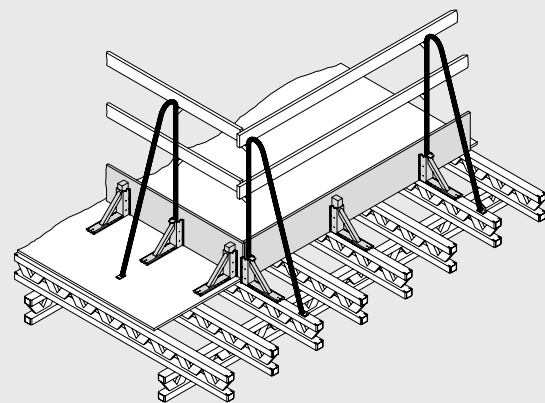

Guardrails on building edges

The open edge of the building is secured with PERI Slab Tables. In the process, guardrails for the slab edge tables are pre-assembled on the ground.

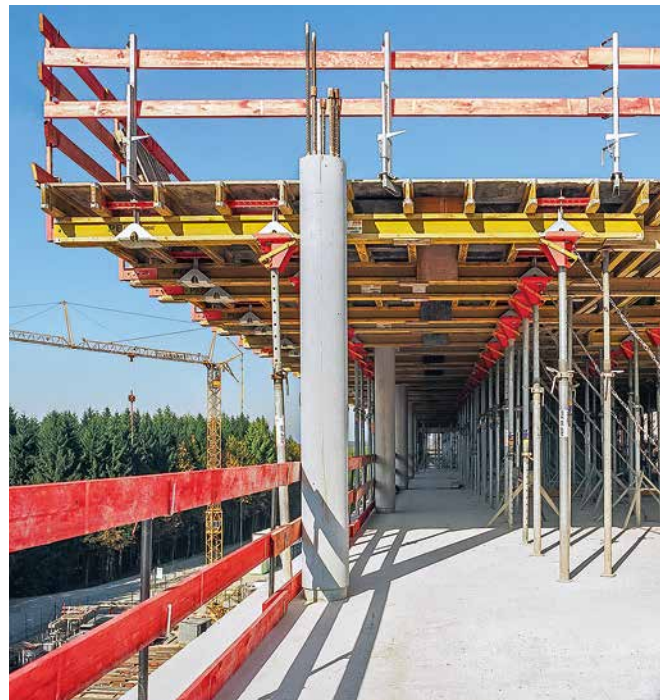
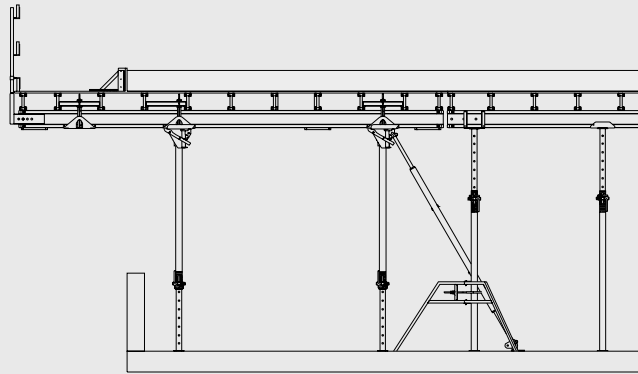

The MULTIFLEX Girder Slab Formwork in use

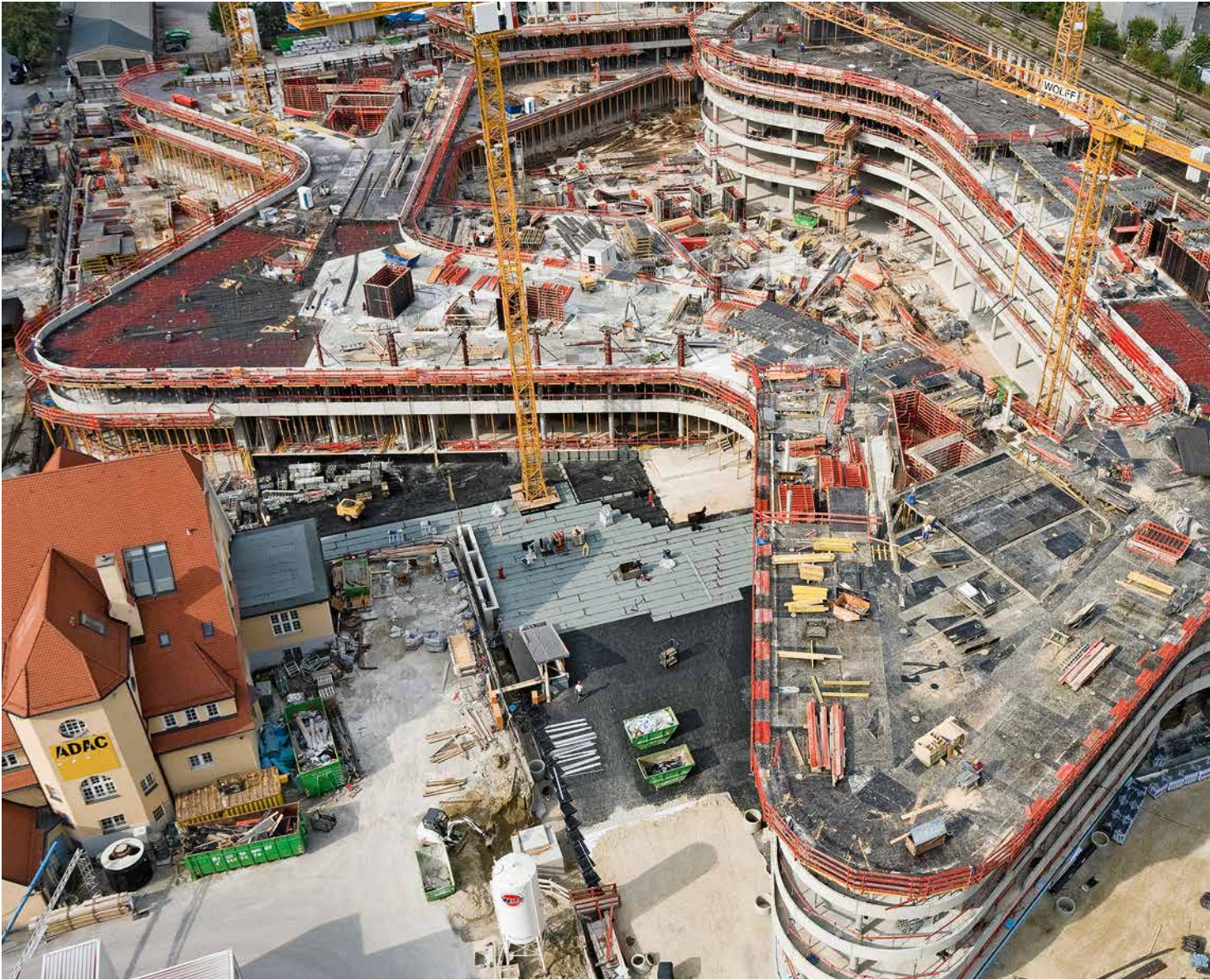

ADAC Headquarters, Munich, Germany

The ADAC has a new headquarters in Munich. The impressive building complex consists of a five-storey, undulating curved base construction with a large courtyard. Above this is an office tower with 18 floors and rounded corners.

The floor slabs of the base construction were formed with modular and customised tables as well as the MULTIFLEX Girder Slab Formwork. The standard table modules could be used for forming the 1.23 m thick reinforced concrete

slab in the basement, strengthened by additional VT 20 Formwork Girders and PEP Steel Tube Slab Props.



The MULTIFLEX Girder Slab Formwork in use



The 30 cm thick reinforced concrete slab was formed with MULTIFLEX.



Complete solution from one source: wall and slab formwork as well as the shoring and reinforcement scaffolding were optimally adapted to match the project requirements.

Ocean Plaza Business Centre, Kiev, Ukraine

The four-storey "Ocean Plaza" is a modern business centre with a total of 250,000 m² of floor space and 3,000 underground parking spaces in downtown Kiev.

The 30 cm thick reinforced concrete slabs were formed using MULTIFLEX with support provided for the standard 3 m floor heights using PEP 20 and MULTIPROP Slab Props. In those areas where loads had to be transferred over great heights, the MULTIPROP Aluminium Props were connected with MRK Frames thus forming a modular shoring tower system.

CIMC Silvergreen Trailer Plant, Günzburg, Germany

For the construction of a new semi-trailer production facility, PERI engineers optimally adapted their formwork solution for the walls and slabs as well as the scaffolding used as shoring, access technology and reinforcement work in order to match project requirements. An important element of the PERI comprehensive solution was the shoring concept for the realization of the cantilevered floor slabs of the administration building along with the in-situ slab construction of the almost 100 m long presentation platform on the north side of the production hall. Here, PERI UP was used for the exact assembly of the prefabricated beams including support at the third points. The scaffolding was then supplemented with the 10 m high load-bearing system – as a sub-structure for the MULTIFLEX Slab Formwork as well as all subsequent work operations with MAXIMO Panel Formwork for constructing the 5 m high architectural concrete wall.

Due to the metric system grid of the PERI UP Flex, the standards in the spatial supporting structure could be adjusted in 25 or 50 cm increments to exactly match all load requirements. Very high load concentrations could be transferred just as easily as low surface area loads. With the help of graduated system steel decking in the same grid, maximum adaptation of the intermediate platforms could also be realized thus resulting in complete coverage.)



MULTIFLEX served for the construction of the cast-in-place beams with the PEP Props connected by means of PRK Frames to form shoring towers.



With PERI UP Rosett and MULTIFLEX, the high loads from the massive structural elements at heights of between 10 m and 12 m were reliably transferred into the ground.

Pérez Art Museum, Miami, USA

The Pérez Art Museum is located directly on Biscayne Bay in Miami. The 3-storey building complex is positioned on a protruding base and is dominated by a boldly projecting cantilevered roof construction.

MULTIFLEX Girder Slab Formwork was used for constructing the large-scale beam structure in an architectural concrete design.

Albian Sands, Fort McMurray, Canada

For the construction of a production plant, massive foundations and rectangular columns along with enormous reinforced concrete beams with heights of 4 m were required. The use of self-compacting concrete resulted in high concrete pressures.

PERI UP Shoring and MULTIFLEX Slab Formwork used for constructing the massive beams impressively proved their high degree of flexibility. Through the planning and supply of formwork and scaffolding from one source, it was possible to perfectly match the MULTIFLEX Slab Formwork and PERI UP Shoring. Both systems complemented each other ideally so that also during the concreting of massive structural elements at large heights, over 40 kN per leg could be safely transferred.

**The optimal System
for every Project and
every Requirement**



Wall Formwork



Column Formwork



Slab Formwork



Climbing Systems



Bridge Formwork



Tunnel Formwork



Shoring Systems



Construction Scaffold



Facade Scaffold



Industrial Scaffold



Access



Protection Scaffold



Safety Systems



**System-Independent
Accessories**



Services



PERI AG
Formwork Scaffolding Engineering
 Rudolf-Diesel-Strasse 19
 89264 Weissenhorn
 Germany
 Tel. +49 (0)7309.950-0
 Fax +49 (0)7309.951-0
 info@peri.com
 www.peri.com

