

PERI UP

Access technology for construction sites,
industry and public areas

Product Brochure – Edition 03/2017



Content

PERI UP	
4	The PERI UP Scaffold Construction Kit PERI UP Flex Modular Scaffolding and PERI UP Easy Frame Scaffolding
6	Distinguishing features of temporary access for construction sites, industry and public areas
Means of access for construction sites and industry	
10	Overview of access means
Ladder access	
14	Vertical ladder access
16	Hatches and access decks
18	Access decks and access decks with ladder
PERI UP Flex Staircase 75	
20	Adjustments in 25 cm increments
22	Height adjustments using brackets
24	Stairwell staircases for access and finishing
26	Access to working areas at a lower level
28	Access from the building to the climbing formwork
PERI UP Flex Staircase 100	
30	Staircase with a 1.00 m width made of lightweight individual components
32	Non-slip access to construction sites or into buildings
PERI UP Flex Staircase 125	
34	Clear width of 1.20 m ideally suited for frequent use

Edition 03 | 2017

Publisher

PERI GmbH
Formwork Scaffolding Engineering
Rudolf-Diesel-Strasse 19
89264 Weissenhorn
Germany
Phone +49 (0)7309.950-0
Fax +49 (0)7309.951-0
info@peri.de
www.peri.de

Access means for public areas
38 Overview of access means

PERI UP Rosett Stair Public
40 Single width continuous staircases as escape or emergency stairs
42 Linked continuous staircases, e.g. for separate directions
44 Bank of continuous staircases of different widths complete with statical proof
46 Dog-legged staircases
48 Stair towers with and without stairwells

Technical data
50 PERI UP access technology at a glance

Important notes

All current safety regulations and guidelines applicable in those countries where our products are used must be observed.

The photos shown in this brochure feature construction sites in progress. For this reason, safety and anchor details in particular cannot always be considered as conclusive or final. These are subject to the risk assessment carried out by the contractor.

In addition, computer graphics are used which are to be understood as system representations. For ensuring a better understanding, these and the detailed illustrations shown have been par-

tially reduced to show certain aspects. The safety installations which have possibly not been shown in these detailed descriptions must nevertheless be available. The systems or items shown might not be available in every country.

Safety instructions and load specifications are to be strictly observed at all times. Separate structural calculations are required for any deviations from the standard design data.

The information contained herein is subject to technical changes in the interests of progress. Errors and typographical mistakes reserved.

The PERI UP Scaffold Construction Kit

PERI UP Flex Modular Scaffolding and PERI UP Easy Frame Scaffolding



With PERI UP scaffolding technology, a minimum number of system components can be used to realize a previously not feasible range of applications. Rosett nodes are integrated on the vertical system components onto which horizontal components can be directly connected without requiring any couplers. This connection technology is not only fast and safe, it also underlines the boundaries between frame and modular scaffolding.

In addition to the special connection technology, PERI UP scaffolding technology offers consistent metric grid dimensions: all PERI UP system components such as standards, ledgers and decks are available in length grid arrangements of 25 cm or 50 cm. The system and decking widths also take into consideration the metre as a base unit.

PERI UP Flex Modular Scaffolding normally uses 25 cm wide steel decks with lengths from 50 cm to 300 cm for

all applications ranging from shoring and various work scaffolds through to access solutions. The PERI UP Easy Frame for use as facade scaffolding is available with 67 cm and 100 cm system widths; depending on the width, it is possible to use 67 wide combi-decking as well as 33 cm or 25 cm wide steel decks.

As all height dimensions of the modular and the frame scaffolding are identical, both applications can also be combined horizontally in an almost unlimited number of ways.

A modular system for all applications

Through the integrated scaffold node on the Easy Frame, PERI UP Easy can be combined with PERI UP Flex Modular Scaffolding. Thus, for example, brackets as well as ledgers for the erection of prefabricated stairs can be quickly connected without requiring any accessories.

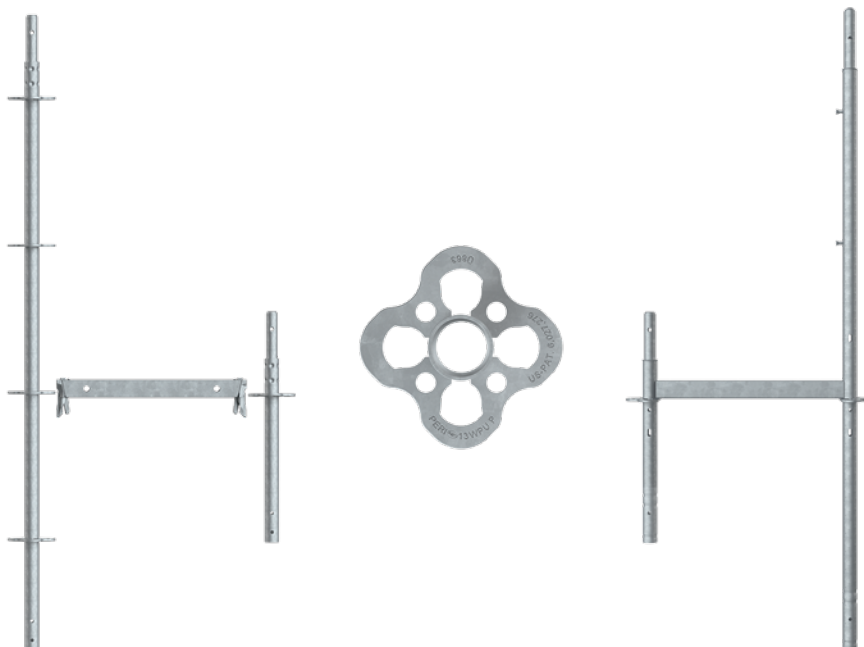

The Gravity Lock for fast and safe ledger assembly

The connection on the PERI UP Ledger is in the form of a wedge which is hooked into the rosette opening. Thereby, the securing wedge drops into the rosette opening due to its own weight and locks automatically. The wedge is then secured in position with one blow of a hammer.



Easy and safe installation and dismantling of the decking

All PERI UP decks have integrated protection against lifting (Locking Deck): the clamp on the deck engages the rectangular ledger without requiring any additional measures. PERI UP decks are thus secured in position after installation without additional components as well as being secured against lifting. If required, individual decks can be subsequently removed, e.g. for bringing in materials.



Fast connection of system components to the rosette node

Ledgers can be directly connected to the rosette nodes of the PERI UP Standards as well as the PERI UP Easy Frame. Thereby, for example, PERI UP Flex Stairs with 75 cm widths can be connected to the frame scaffolding without any additional frame columns or couplers. The transition from the stairs to the scaffold bay is covered without leaving any gaps, therefore no gap covering is required.

Distinguishing features of temporary access

Ladders and stairs are used for temporary access of levels with different heights. The range of applications extends from stairs with only a few steps through to stair towers that are over 90 m high.

Selection takes place according to the intended use and thereby also determines the requirements placed on geometry, permissible load and the actual users.

PERI supports its customers through the development of customized solutions. At the end, the customer receives the officially-approved required plans together with the relevant statical proof which is needed for acceptance and release.

Means of access for construction sites and industry

Ladders and stairs are used for accessing higher positioned working areas or entering construction sites as well as industrial facilities. Authorised users are all those involved in the building project, i.e. persons in appropriate working clothes with suitable protection equipment.

→ see page 8

The most important construction types

Ladder access

This includes vertical ladders with ladder safety cages as well as access decks or hatches with inclined ladders which are firmly attached. Examples are external ladders for column formwork or internal ladders which connect two levels with one another.

Staircases up to 2.0 kN/m²

These are mounted on working scaffolds or erected as separate stair towers. With their typical level height of 2.00 m and landings integrated in the flights of stairs, they are space-saving and inexpensive.

Staircases for 3.0 kN/m²

Featuring stair flights with widths starting from 1.00 m and separate landings, these staircases are ideally suitable for large construction sites, industrial applications as well as rescue operations for injured persons. They can be erected as stair towers or dog-legged staircases around a stair well.

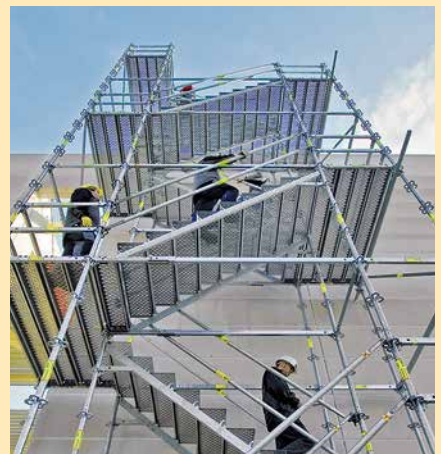
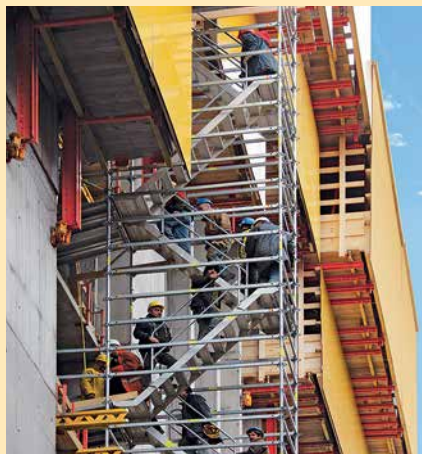

Access means for public areas

The most important requirements for temporary access in public areas are broad stairs which are easily accessible and are suitable for large crowds of people. Users are all persons who use public areas, from small children through to frail elderly people.

→ see page 36

Additional information

■ Escape stairways

A set of stairs which serve as an emergency escape route is known as escape stairways.

■ Fire escapes

They can be attached to an existing building as a second escape route - the structure may be undergoing modification work at the time. The staircase and landing will only extend one storey height and must end on a safely accessible level, and give access to another level where rescue by ladder or similar is possible.

The most important construction types

Single or linked continuous staircases

The statutory minimum width of these stairs is 120 cm and extensions must be carried out in 60 cm increments. System scaffolds fulfil guidelines with widths of 150 cm, 200 cm and 250 cm. A landing is fixed in position at regular intervals on the staircase. Several single continuous staircases next to each other result in a bank of continuous staircases of any width.

Dog-legged staircases

If single continuous staircases are further installed at a 90° angle from the landing, this results in so-called dog-legged staircases.

Stair towers

A special arrangement of dog-legged staircases results in a stair tower. This is usually comprised of alternating staircase units and features landings on the front sides.



Means of access for construction sites and industry





Overview of access means

Ladder access, hatches and access decks with ladder

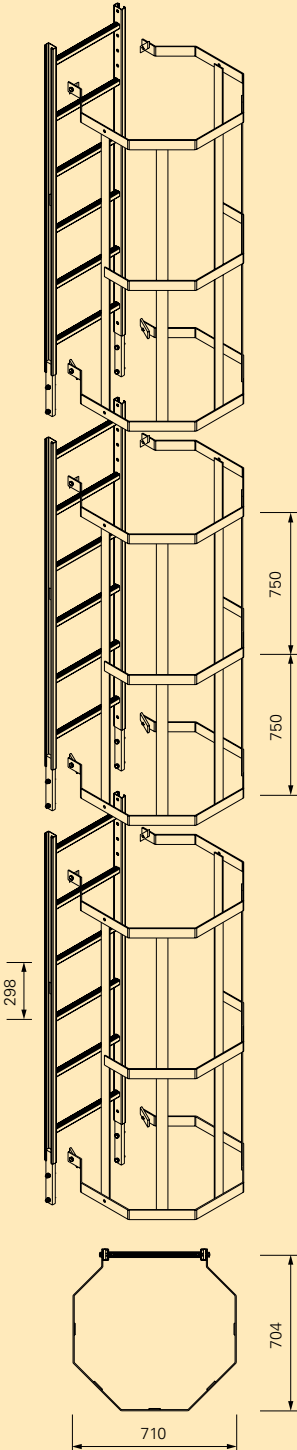
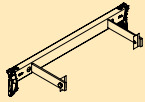
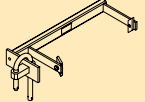
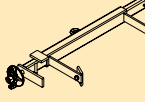
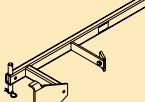
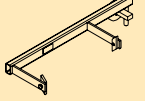
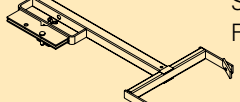
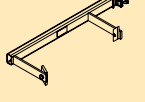
Vertical ladder access		→ see page 14
Ladders and ladder safety cages	Ladder connectors for	
	 PERI UP Flex Modular Scaffolding	
	 RAPID Column Formwork	
	 VARIO Column Formwork	
	 TRIO Panel Formwork	
	 QUATTRO Column Formwork	
	 SRS Circular Column Formwork	
	 HD 200 Heavy-Duty Prop	

Hatches and access decks (PERI UP Flex Modular Scaffolding)

→ see page 16

Hatches with non-integrated ladder

Access decks with non-integrated ladder

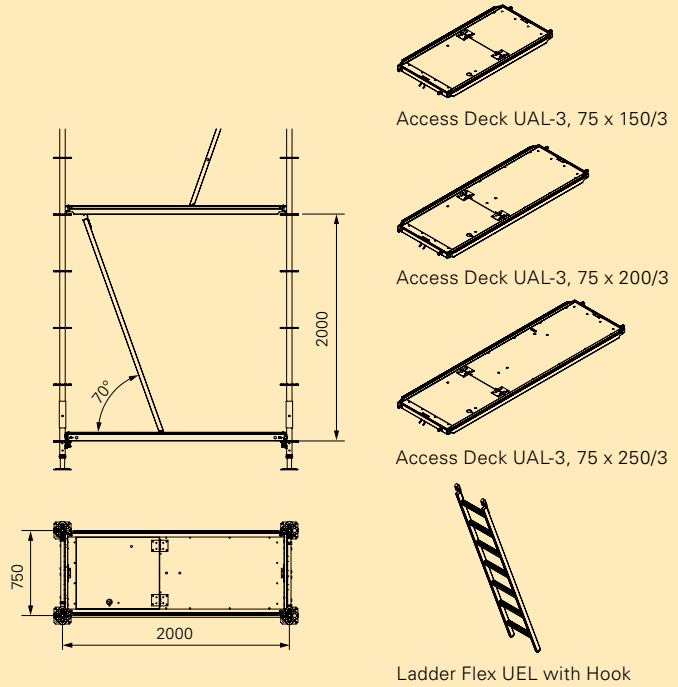
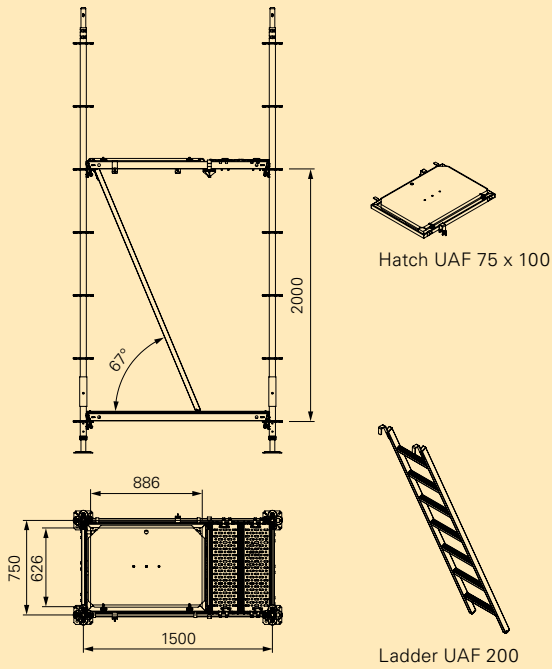

Access Decks and Access Decks with Ladder (PERI UP Easy Frame Scaffolding)

→ see page 18

Access decks with non-integrated ladder

Access decks with integrated ladder

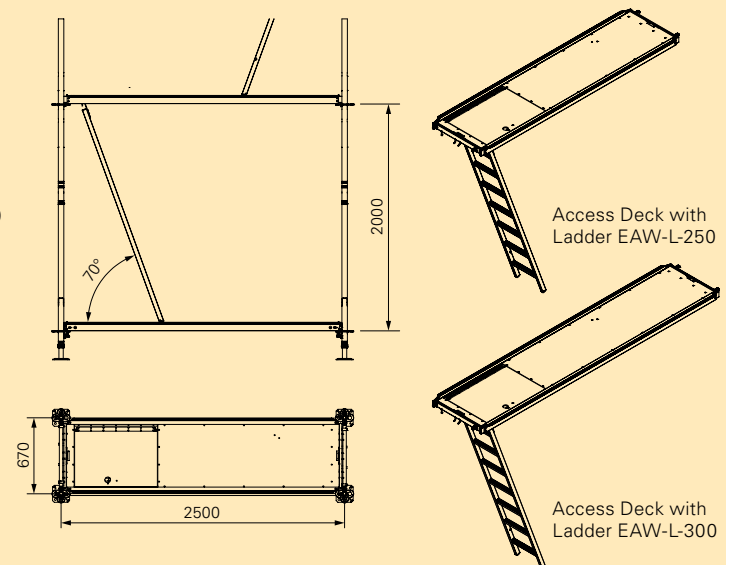
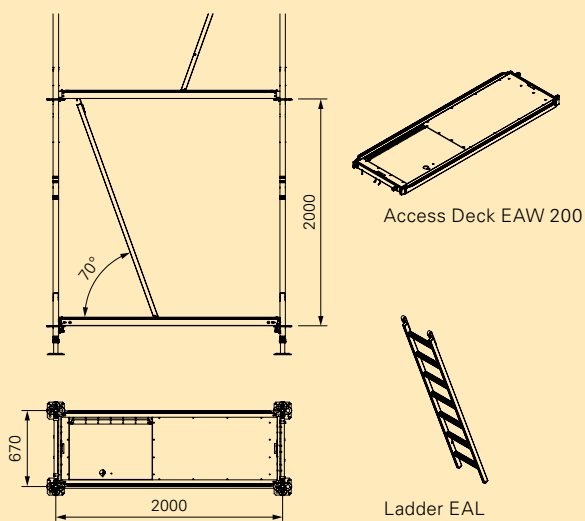

Overview of access means

Staircases up to 2.0 kN/m² and for 3.0 kN/m²

Staircases up to 2.0 kN/m²

→ see page 20

PERI UP Flex Staircase 75

Staircase units in
the same
direction

Alternating
staircase units

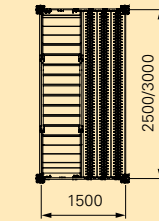
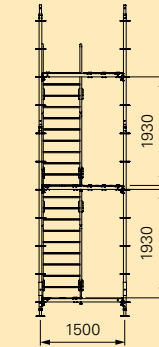
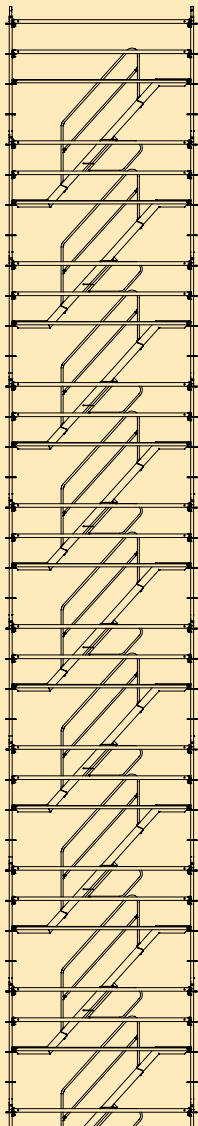

Flight of
stairs

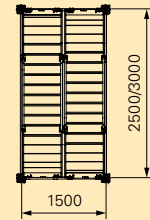
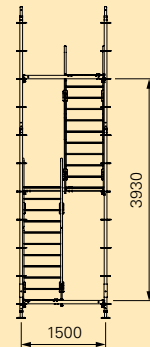
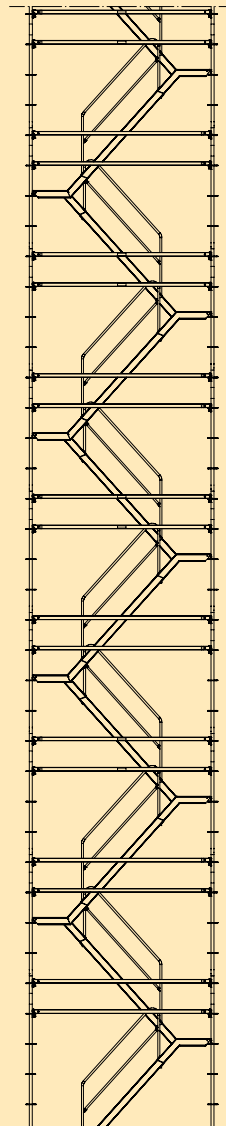

Staircases for 3.0 kN/m²

→ see page 30

**PERI UP Flex
Staircase 100**

Staircase units in
the same
direction

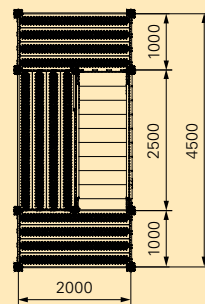
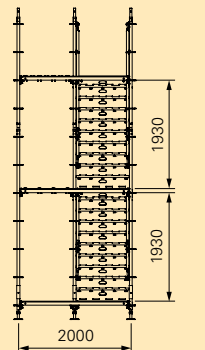
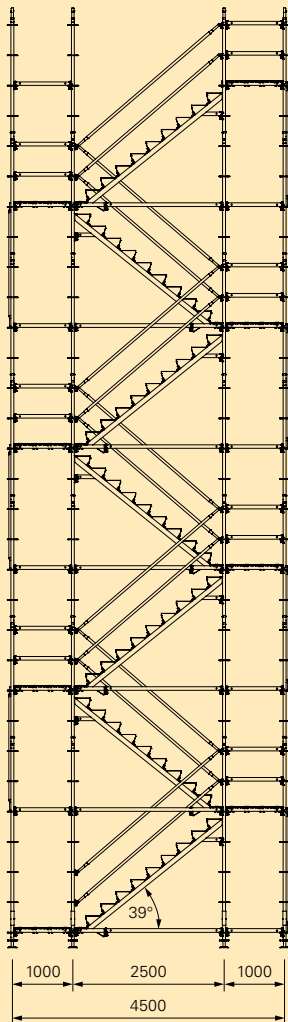

Alternating
staircase units

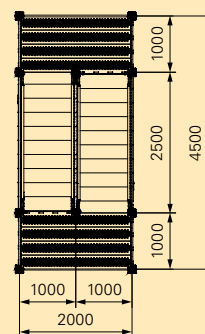
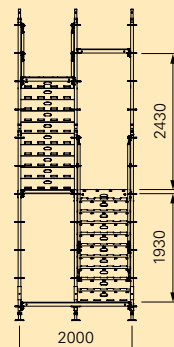

**PERI UP Flex
Staircase 125**

Staircase units in
the same
direction

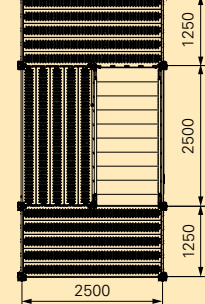
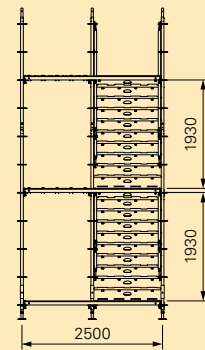
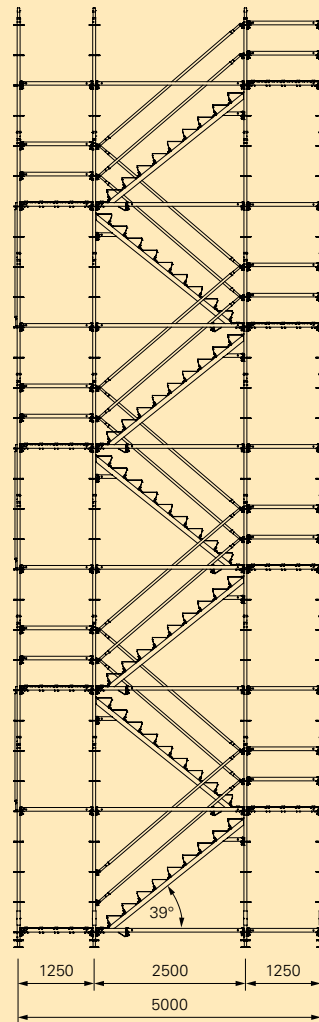

Alternating
staircase units

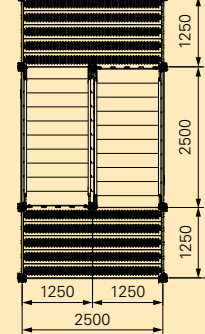
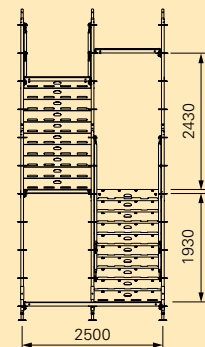

Vertical ladder access

Accessing platforms positioned at great heights

On high and slender elements such as columns or chimneys, vertical ladder access is the most inexpensive solution.

In sections of approx. 2.00 m, the ladders are connected to the scaffolding. The clampable ladder safety cage provides site personnel with very safe conditions for climbing up and down.

With vertical ladder access, large heights can be reached in the shortest way – however, without the possibility of transporting materials at the same time.

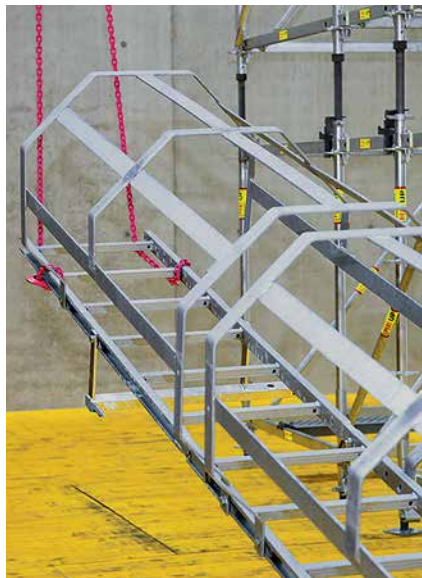

Pre-assembly of the ladder complete with ladder connections and ladder safety cage on the ground.



Lifted into position by crane, the wedges are then fixed using a hammer.

Suitable ladder connections are available for the various PERI systems. These are used to attach the ladders and ladder safety cages in individual sections.

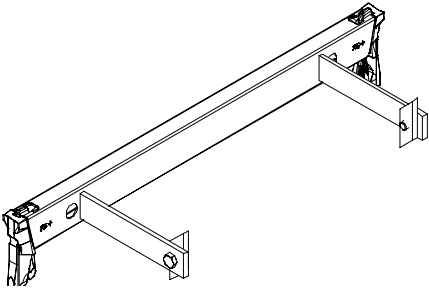

In addition, ladder connections are also available for different column formwork systems.



PERI UP Flex Modular Scaffolding

Ladder Connection UAC

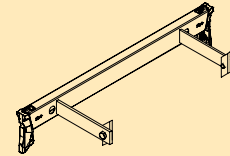

Ladder Safety Cage 75 Ladder Safety Cage 150

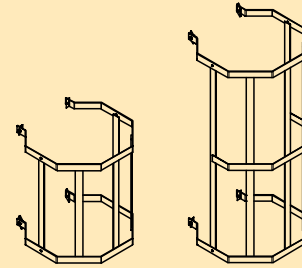

Ladder 180/6

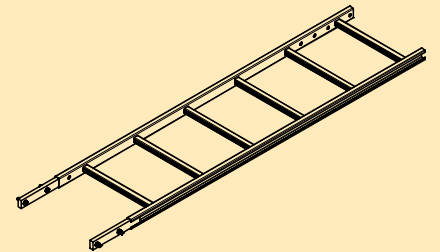

End Ladder 180/2

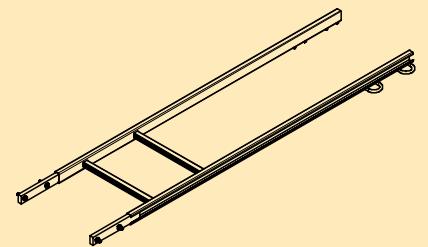

Ladder Base

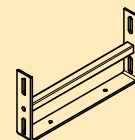

Hatches and access decks

Solutions for manholes and small bay sizes

Scaffold users often have to change working levels within the scaffolding itself. Hatches and access decks allow site personnel to safely reach the scaffolding level above or below.

Hatches consist of a frame with access opening and short decking piece as well as an attached ladder. If hatches are used inside containers, often only small manholes (approx. 55 cm or 22 inches) are available for material transport. Hatches are also a suitable solution for short bay lengths.

The access deck consists of a hatch that functions as an access opening which is integrated in a longer deck, as well as an attached ladder. The hatch can be opened for climbing through and then closed again afterwards. When closed, the hatches and access decks can be used as working areas.

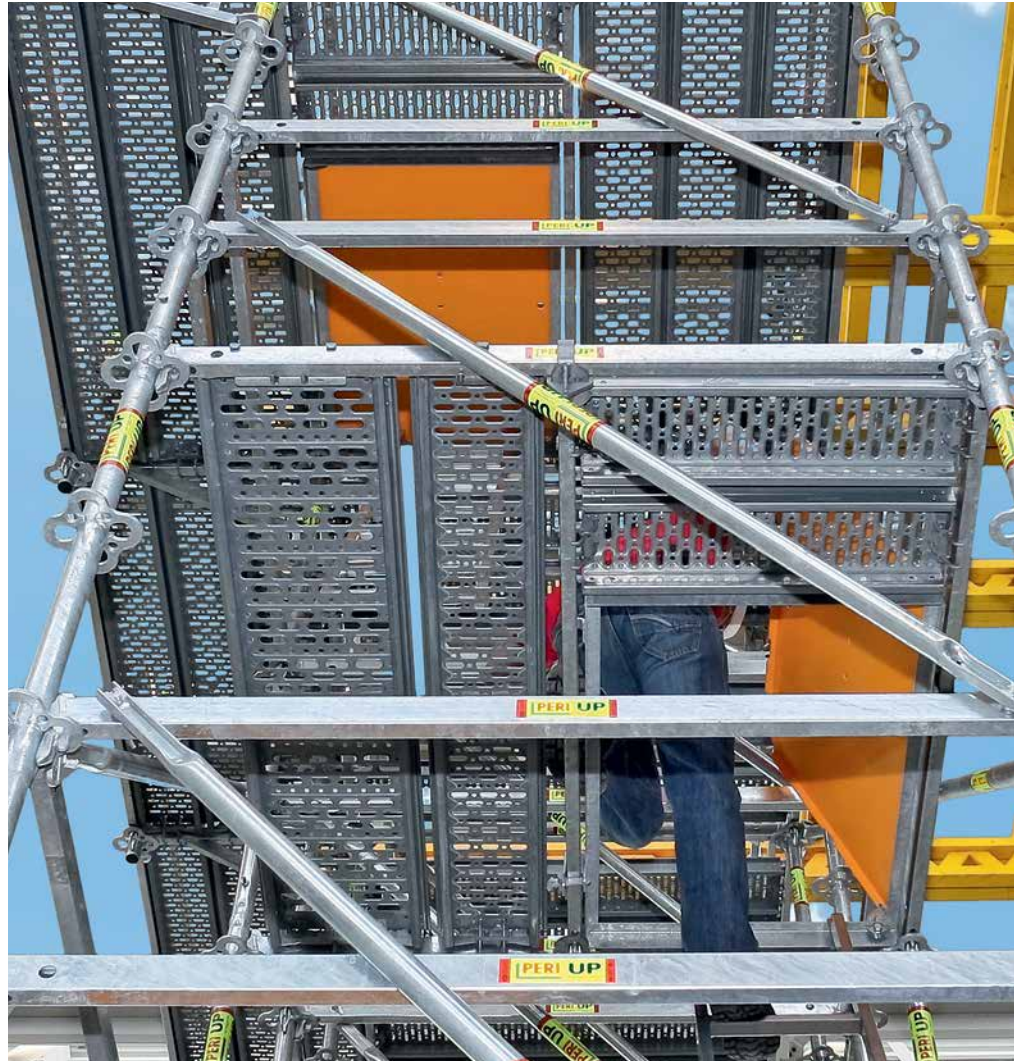

As access to the upper working platforms on shoring towers, hatches with separate ladders can also be used in bays with lengths of only 1.50 m.



Hatches painted in a yellow signal colour can be opened in a sideways direction. They close automatically which eliminates any source of danger.



Hatches with widths of 50 cm and 75 cm can also be installed in bays with small lengths.



The access deck facilitates changing the working level for the scaffold user.

PERI UP Flex Modular Scaffolding

Hatch UAF 75 x 100

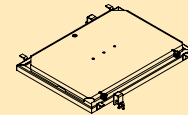

Ladder UAF 200

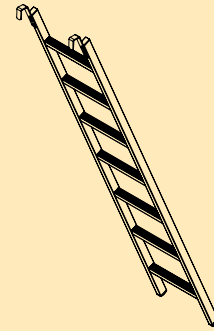

Access Deck UAL-3, 75 x 150/3 Access Deck UAL-3, 75 x 200/3 Access Deck UAL-3, 75 x 250/3

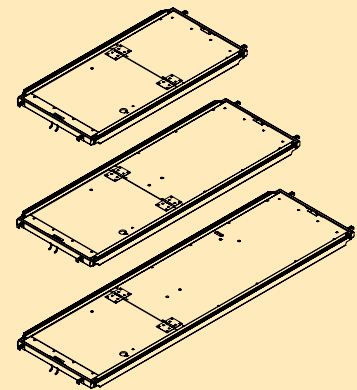

Ladder Flex UEL with Hook

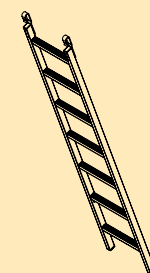

Access decks and access decks with ladder

Decking with ladder for facade scaffolding

For facade working scaffolds, access decks and ladders connect the different working levels. These means of access are the easiest and fastest to mount of all possibilities as well as being especially cost-effective.

Access decks with ladders are available in lengths of 2.50 m and 3.00 m which allows the integrated ladders to be folded up under the deck when not in use. If the integrated ladder is folded upwards and the hatch closed, the complete width of the scaffolding can then be used. If the facade scaffolding is particularly long, then access decks with ladders can be installed approx. every 20 m in order to reduce walking distances.

Alternatively, access decks with separate hook-in ladders can be used. For the PERI UP Easy Frame Scaffolding, access decks and access decks with ladder are available with a width of 67 cm.



Small facade scaffolding is quickly and safely accessible only after access decks with ladders have been installed.





PERI UP Easy Frame Scaffolding

Access Deck EAW-L 200

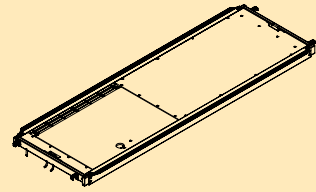

Ladder EAL

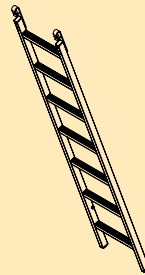

Access Deck EAW-L 250 with Ladder
Access Deck EAW-L 300 with Ladder

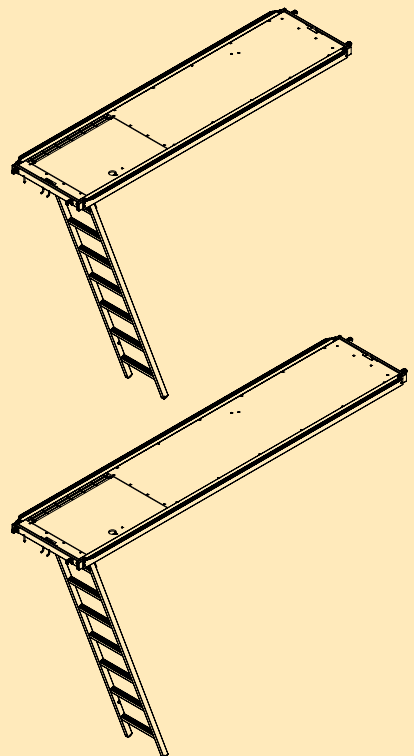

PERI UP Flex Staircase 75

Adjustments in 25 cm increments

The staircase units have the grid dimensions of the PERI UP Flex Scaffold and provide a high level of flexibility along with all the advantages of modular scaffolding. The 75 cm wide staircases serve as access means to working areas or construction sites, and reach heights of up to 90 m.

All decking widths as well as the PERI UP Flex Staircase 75 match the grid dimensions of the standards and ledgers (25 cm or 50 cm). These are mounted on UH Ledgers. All this results in a high degree of flexibility regarding scaffold adjustment.

Height adjustments to building openings are carried out independently of the floor heights by means of brackets and short flights of stairs (1.50 m long, 50 cm/100 cm high).

Due to the grid dimensions of 25 cm, staircase units can be installed next to each other and upward and downward movements are separated by means of handrails inserted in the stringers.

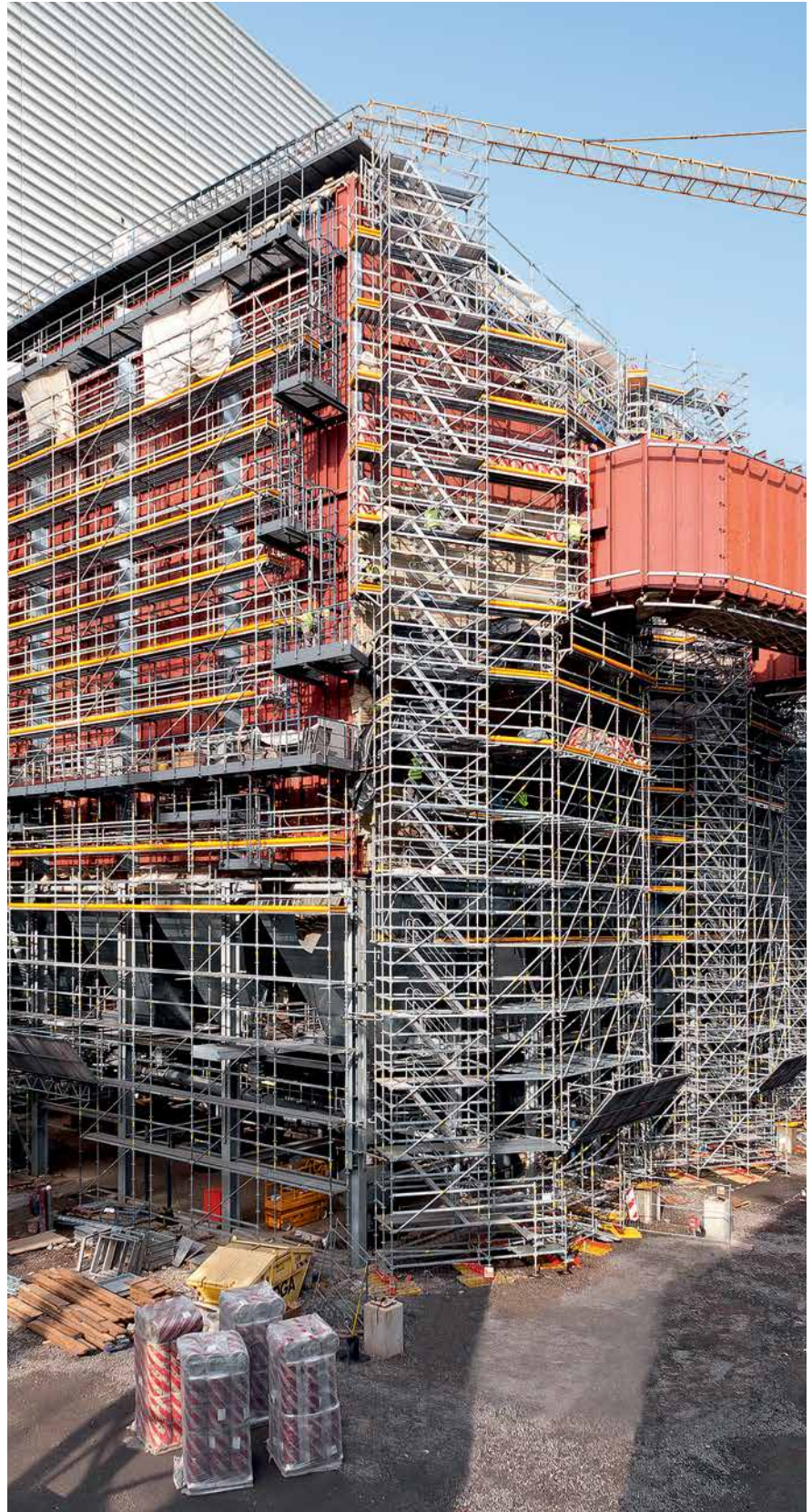

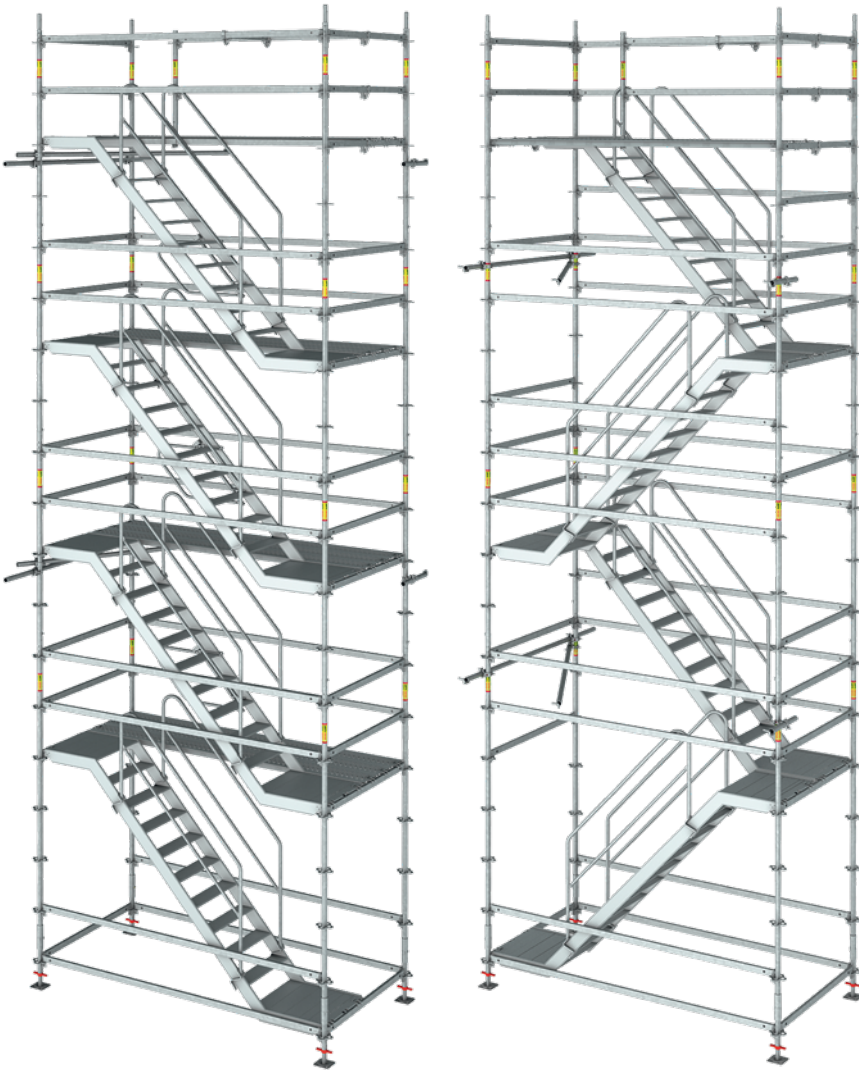

Stair towers with staircase units in the same direction have the advantage that, in addition to staircase units, working levels are also available.

Stair tower with alternating staircase units provide greater head clearance and shorter walking distances for site personnel accessing the higher levels.



PERI UP Flex Modular Scaffolding

Stair Guardrail UAG

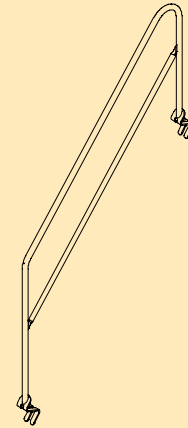

Staircase UAS 75 x 250/200 Staircase UAS 75 x 300/200

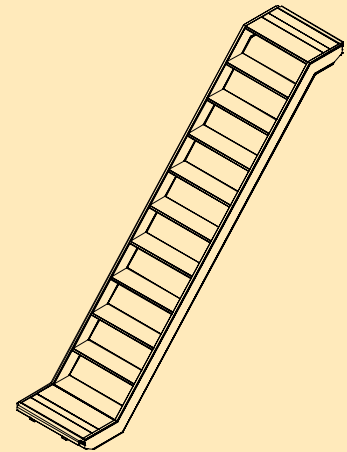

Stair Guardrail UAH

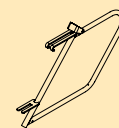

PERI UP Flex Staircase 75

Height adjustments using brackets

Height adjustments take place by means of the laterally mounted brackets. As a result, the stair tower floor height of 2 m remains constant over the entire height which simplifies planning and assembly.

For stabilising the brackets, installation of a few additional components in the stair tower is sufficient. Additional anchors are not necessary.

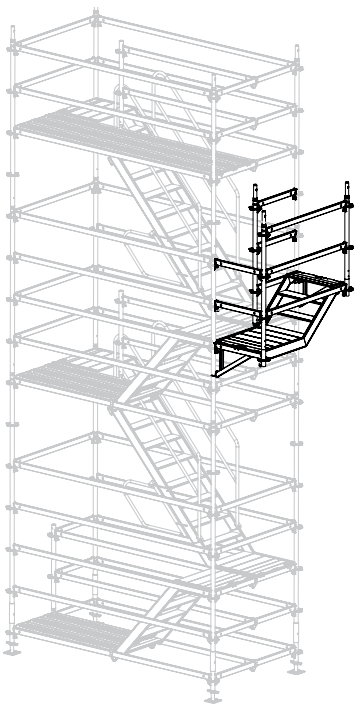

The stair tower is erected using regular floor heights of 2.00 m. Adjustments to the openings on the building are carried out on brackets – suspended on the outside – with short staircase units of 1.50 m in length and heights of 50 or 100 cm.



With the "ledger-to-stair" which is attached on a step, height adjustments up to 50 cm can be created by means of industrial decking as a ramp.

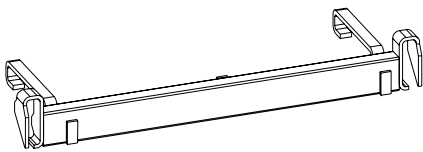

Smaller height adjustments are carried out using ramps with industrial decking, whereby the rectangular profile for fixing the decks through the "ledger-to-stair" procedure is mounted on a step.

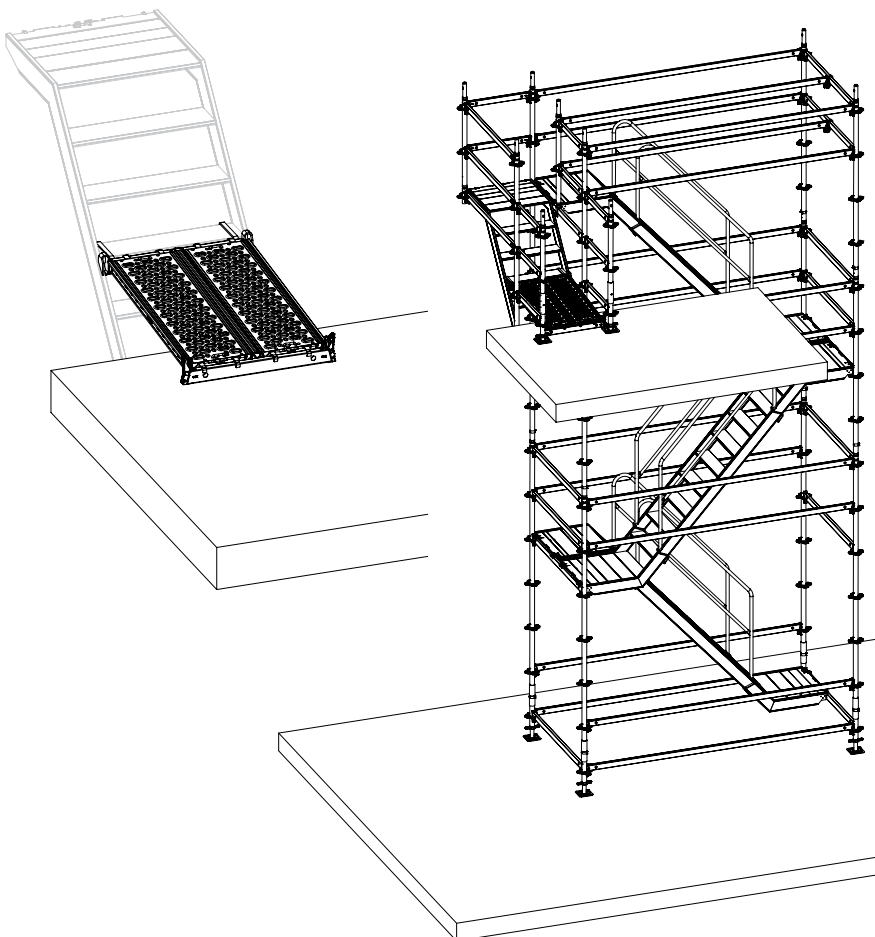

PERI UP Flex Modular Scaffolding

Console Bracket UCM 75 with Spigot

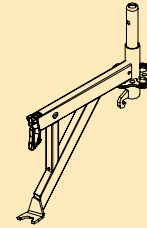

Staircase UAS 75 x 150/50 S Staircase UAS 75 x 150/50 T

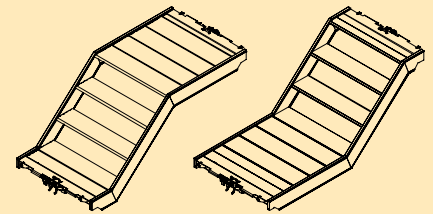

Staircase UAS 75 x 150/100 S Staircase UAS 75 x 150/100

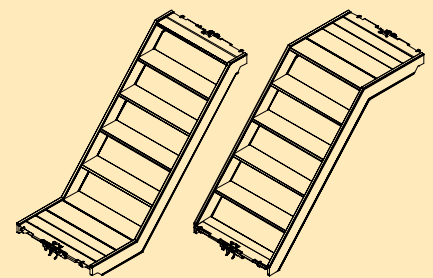

Ledger on Staircase UAS 75

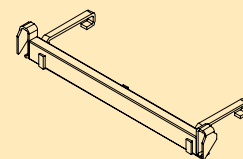

PERI UP Flex Staircase 75

Stairwell staircases for access and finishing

With the stairwell staircases, compact access means can be provided on the inside of buildings with small staircase wells. At the same time, the stairs serve as working platforms for carrying out further work on the sides of the walls.

The staircase units have the grid dimensions of the PERI UP Flex Modular Scaffold and offer the required adaptability of stairs to suit small areas and narrow geometries.

With standard components, accesses can be created to all floors using height increments of 25 cm. Standard configurations are available for the common floor height of 2.75 m.



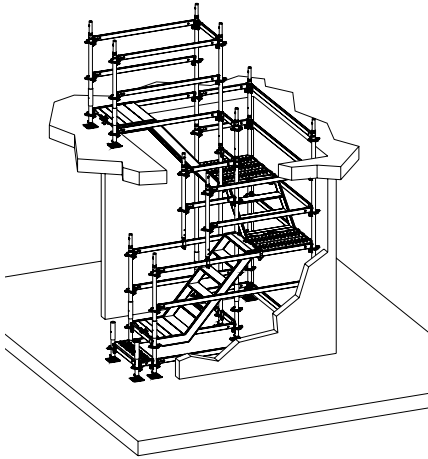

Standard stair configuration for a 2.75 m floor height:
Rectangular ground plan with clear dimensions between the walls of 2.10 m x 2.20 m.

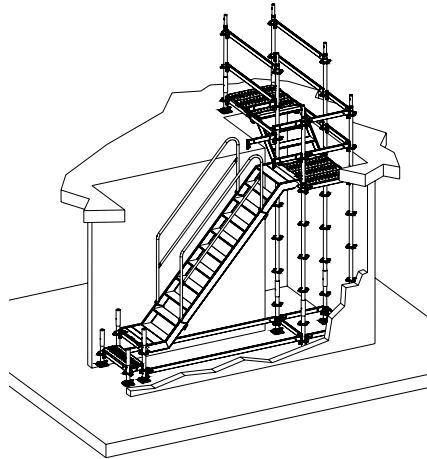

Standard stair configuration for a 2.75 m floor height:
L-shaped ground plan with clear dimensions of 3.40 m x 1.00 m and 1.20 m x 1.00 m.

Solution for small spaces

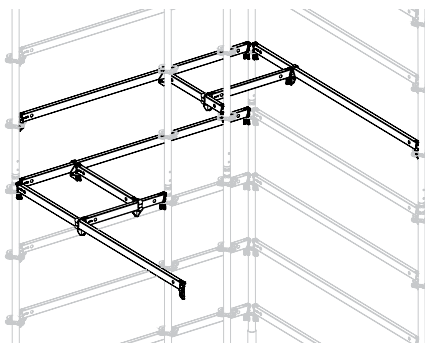
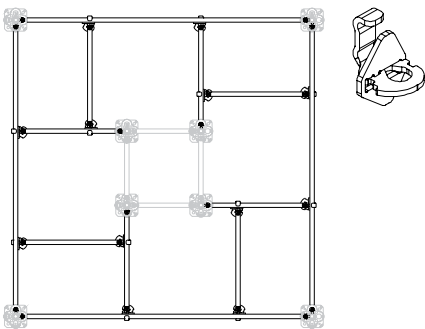

Ledgers under an angle of 90 degrees are mounted at the same height using ledger-to-ledger couplers.

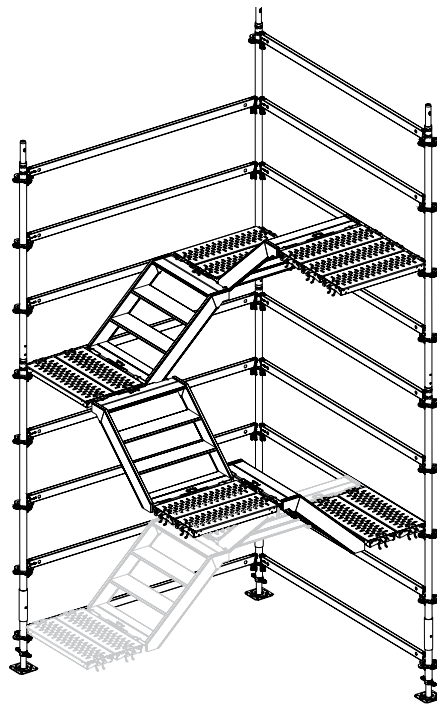

Decks and stairs are positioned on the ledgers. Due to the grid dimension of 25 cm, all bays can be completely closed leaving no gaps.

PERI UP Flex Modular Scaffolding

Staircase UAS 75 x 75/50

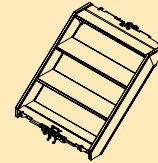

Staircase UAS 75 x 150/50 S
Staircase UAS 75 x 150/50 T

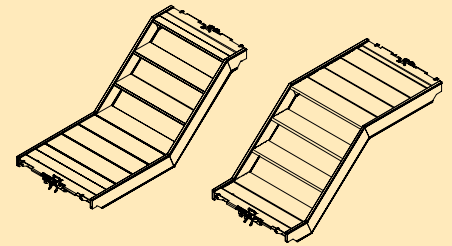

Staircase UAS 75 x 150/100 S
Staircase UAS 75 x 150/100

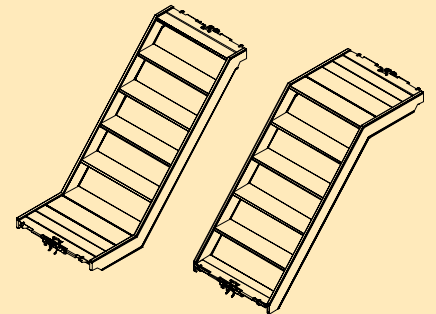

PERI UP Flex Staircase 75

Access to working areas at a lower level



PERI UP Stair Towers are particularly fast and cost-effective to install if the standards are tightly connected to each other and complete stair sections are moved with the crane.

Suspended stairways can also be used for accessing climbing formwork or in shafts, e.g. subway construction. The standards are tightly connected by means of bolts and nuts whereby each connection can transfer up to 19.7 kN permissible tension force. Theoretically, this means up to 40 scaffolding levels can be installed as suspended scaffold.

The suspended working platforms cantilevered up to 5 m were designed so that the complete underside of the bridge in the cantilevered area was accessible and could be worked on. An integrated stair tower ensured fast and convenient accessibility to the different working levels.



Two mobile PERI Suspended Scaffolds provided optimal access to the underside of a motorway bridge.



Due to site-compliant system combinations of the VARIOKIT Engineering Construction Kit and the PERI UP Flex Modular Scaffolding System, flexible and project-specific, optimized site solutions are possible.

Basic scaffold

The basic scaffold forms a falsework for the pre-assembly of individual units on the ground. The units can be positioned on existing stair sections with the crane.

A suspended stair tower can be extended downwards at any time.

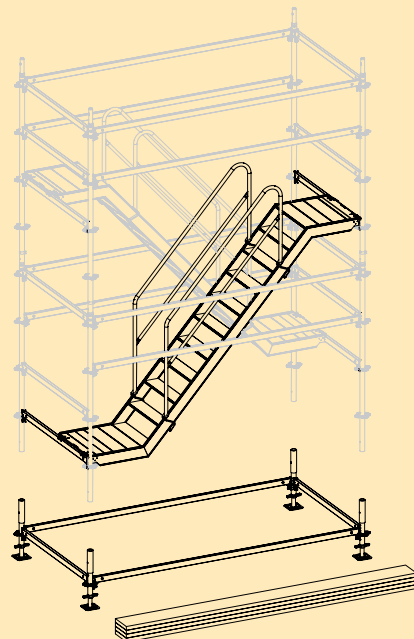

PERI UP Flex Staircase 75

Access from the building to the climbing formwork



In general, staircases are erected in front of or in a building and connect the ground with different levels of the building. The fact that staircases on the construction site can be used completely differently is shown by the examples on this page.

With climbing formwork, climbing brackets can be used as a base for the stair tower. This means they are not dependent on any foundation measures on the ground and can connect finishing platforms with different floors of the building.

In combination with rentable system components from the VARIOKIT Engineering Construction Kit, an RCS Landing Platform serves as an erection area for a 4- and 6-storey stair tower. The PERI UP Staircase provides continuous access to the top floors regardless of how the assembly of the prefabricated stairs in the building core is progressing.



PERI UP Flex Modular Scaffolding

Triangular anchor on the inner and outer legs

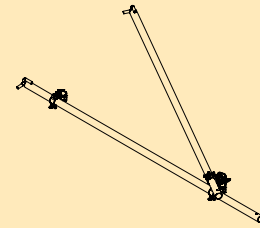

Short wall tie only on the inner leg



Apart from the anchorage for the standard configuration shown above, a wide range of other solutions is available which are planned and calculated by PERI according to project specifications. This includes, for example, solutions for large wall spacings or anchoring on climbing rails.

PERI UP Flex Staircase 100

Staircase with a 1.00 m width consisting of lightweight individual components

The PERI UP Flex Staircase 100 is erected as a 10-leg tower complete with separate landings, and used on construction sites with high requirements regarding loads and accessibility.

With a step width of 100 cm, the stair tower provides easy and comfortable access – with sufficient space for site personnel to pass each other. With a permissible load of 3.0 kN/m², it can be assembled up to a height of 50 m. Assembly is simple and fast without requiring any tools: the stringers are mounted first, followed by the steps which interlock during installation. The top step secures all the others.

For accommodating 3.0 kN/m², the staircase is erected as a 10-legged tower with alternating staircase units and separate landings. The landing widths can be selected as required but should be at least the width of the stairs.

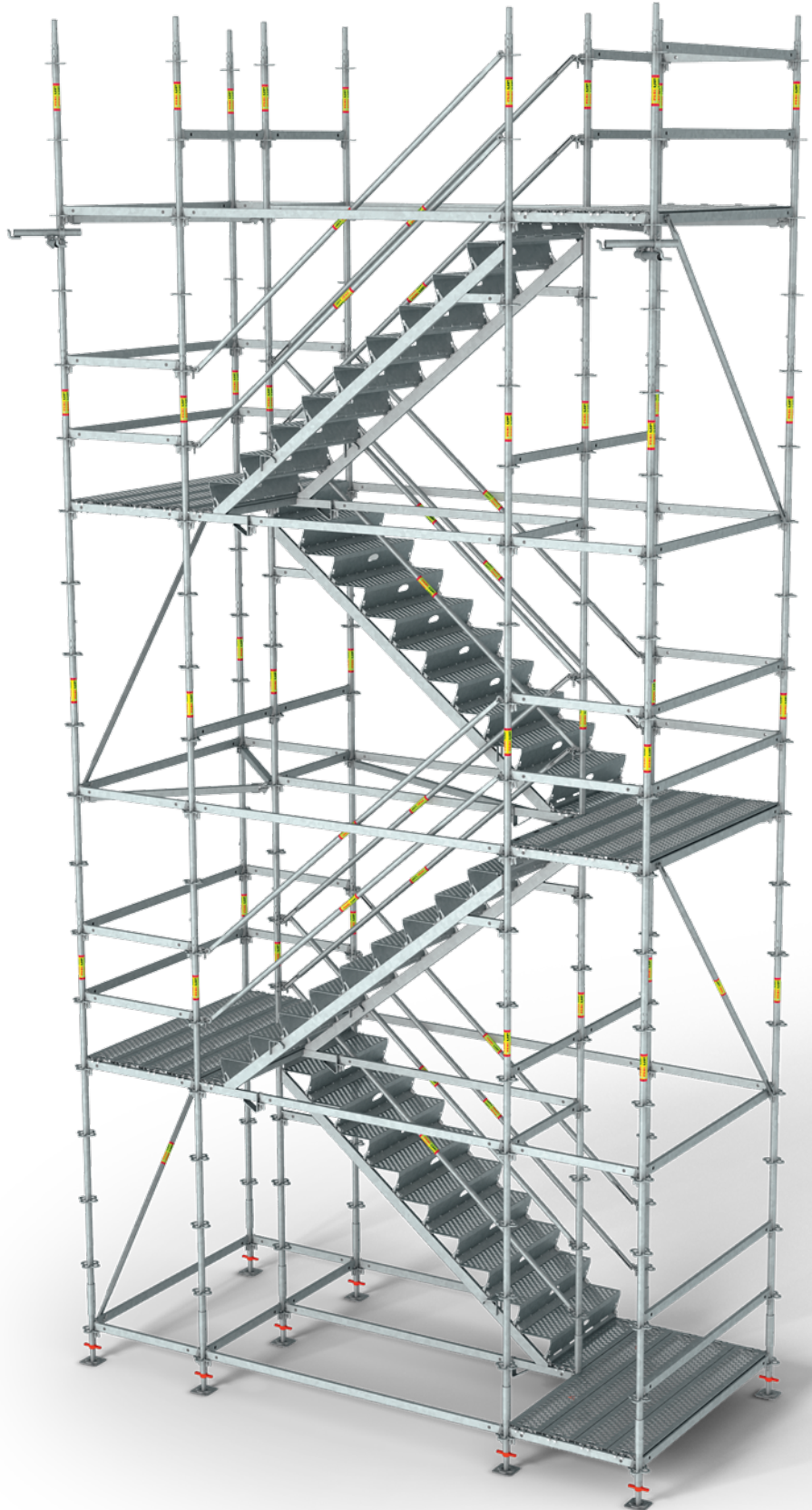



The stair width of 100 cm is easily accessible with sufficient space for site personnel to pass each other as well as for rescuing injured persons.

Assembly without tools: the second step is securely connected to the previous step simply by placing in position and turning.

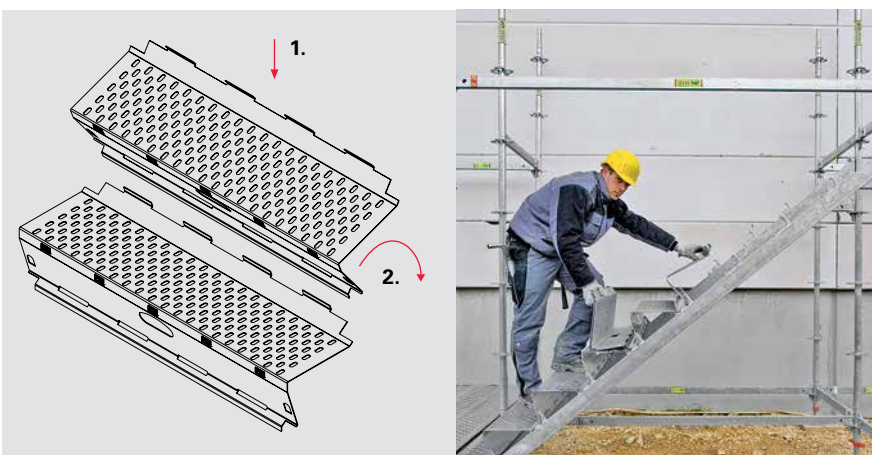

PERI UP Flex Modular Scaffolding

End Step UAE 100 End Step UAE 100

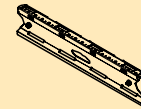

Stair Step UAR 100

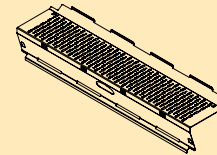

Stair Stringer UA 125/100
Stair Stringer UA 250/200

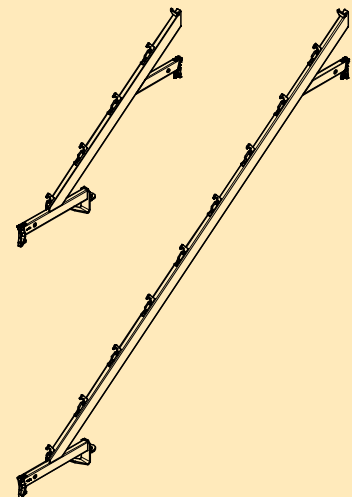

PERI UP Flex Staircase 100

Non-slip access to construction sites or into buildings



Besides a safe transfer of loads, slip resistance is an important requirement for all stairs. The steps of the PERI UP Flex Staircase 100 are perforated like the UDG Decks. The trumpet-shaped openings are bent upwards and are safe to use even with oil-smearred shoes. With an additional edge profile on the ledgers at the start of the stairs, the upper corner is also slip resistant.

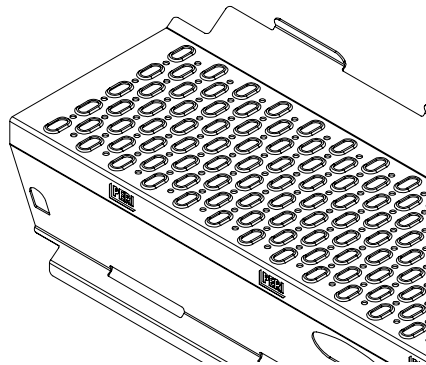

The possibility of small objects falling to the ground is also prevented: the steps are fitted with closed webs while toe boards along the landing edges provide an additional safety feature.

Photo left:
The PERI UP Flex Staircase 100 is ideally suited for use as construction site access. The maximum live load of a tower is 40 kN.

The toe boards along the landings prevent small objects from falling to the ground.



Perforated step surfaces and decking provide a high level of slip resistance. At the same time, ice formation is made difficult in the winter as water drains away leaving little water to freeze.



PERI UP Flex Modular Scaffolding

Toe Board Steel UPY 150
Toe Board Steel UPY 200

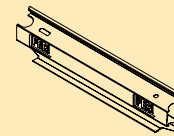

Steel Deck UDG 25 x 50
Steel Deck UDG 25 x 75
Steel Deck UDG 25 x 100
Steel Deck UDG 25 x 125
Steel Deck UDG 25 x 150
Steel Deck UDG 25 x 200
Steel Deck UDG 25 x 250
Steel Deck UDG 25 x 300

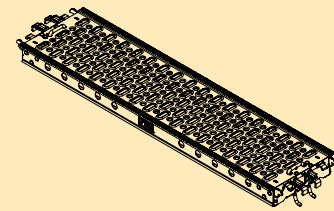

Industrial Deck Steel UDI 25 x 50
Industrial Deck Steel UDI 25 x 75
Industrial Deck Steel UDI 25 x 100
Industrial Deck Steel UDI 25 x 125
Industrial Deck Steel UDI 25 x 150
Industrial Deck Steel UDI 25 x 200
Industrial Deck Steel UDI 25 x 250
Industrial Deck Steel UDI 25 x 300

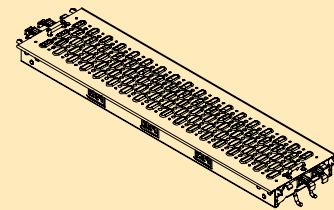

Edge Profile UH 100

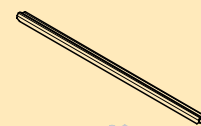

PERI UP Flex Staircase 125

Clear width of 1.20 m ideally suited for frequent use

The flights of stairs of the PERI UP Flex Staircase 125 differ from the PERI UP Flex Staircase 100 only through the wider steps; all other components are the same. The maximum height of the stairs in the standard configuration is limited to 40 m due to the larger areas for the live loads.

With step widths of 125 cm, the clear width of 120 cm between the legs that is required in some countries is fulfilled. Based on the average shoulder width of 60 cm, convenient and comfortable passing on the stairs is possible. Using this staircase is both practical and sensible on those construction sites where the stairs are in frequent use by the workers.

The PERI UP Flex Staircase 125 has a clear width of 120 cm between the legs of the modular scaffold and can be easily and safely accessed by site personnel carrying tools or building materials.

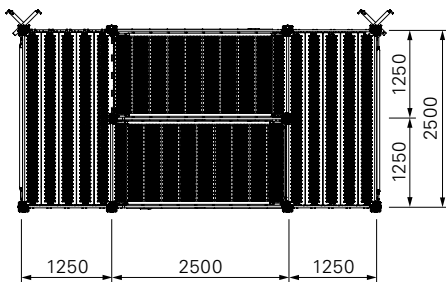

Comfortable access, fast rescue of injured persons on stretchers, wide landings with lightweight individual components as before which are installed without the need of tools are the main features of the PERI UP Flex Staircase 125.

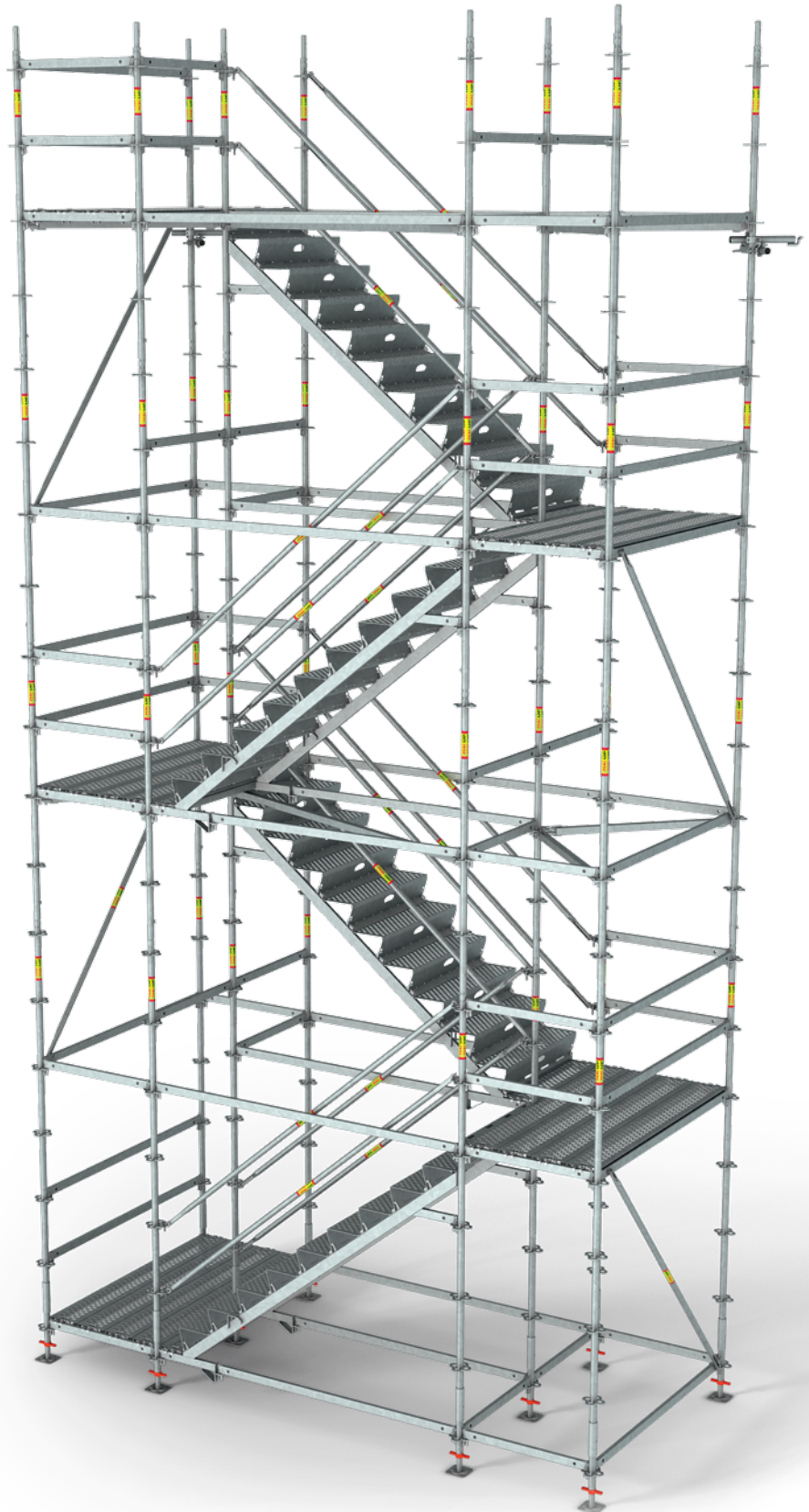



Wide staircases for accessing the form-work and concreting levels during the construction of a dam.

PERI UP Flex Modular Scaffolding

End Step UAE 125

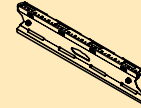

Stair Step UAR 125

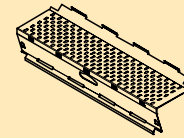

Stair Stringer UA 125/100 Stair Stringer UA 250/200

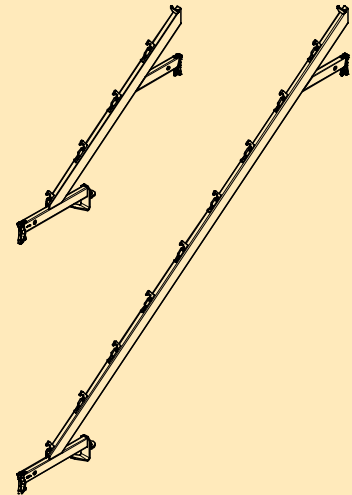

Edge Profile UH 125

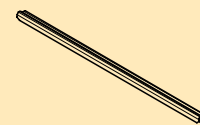

Access means for public areas

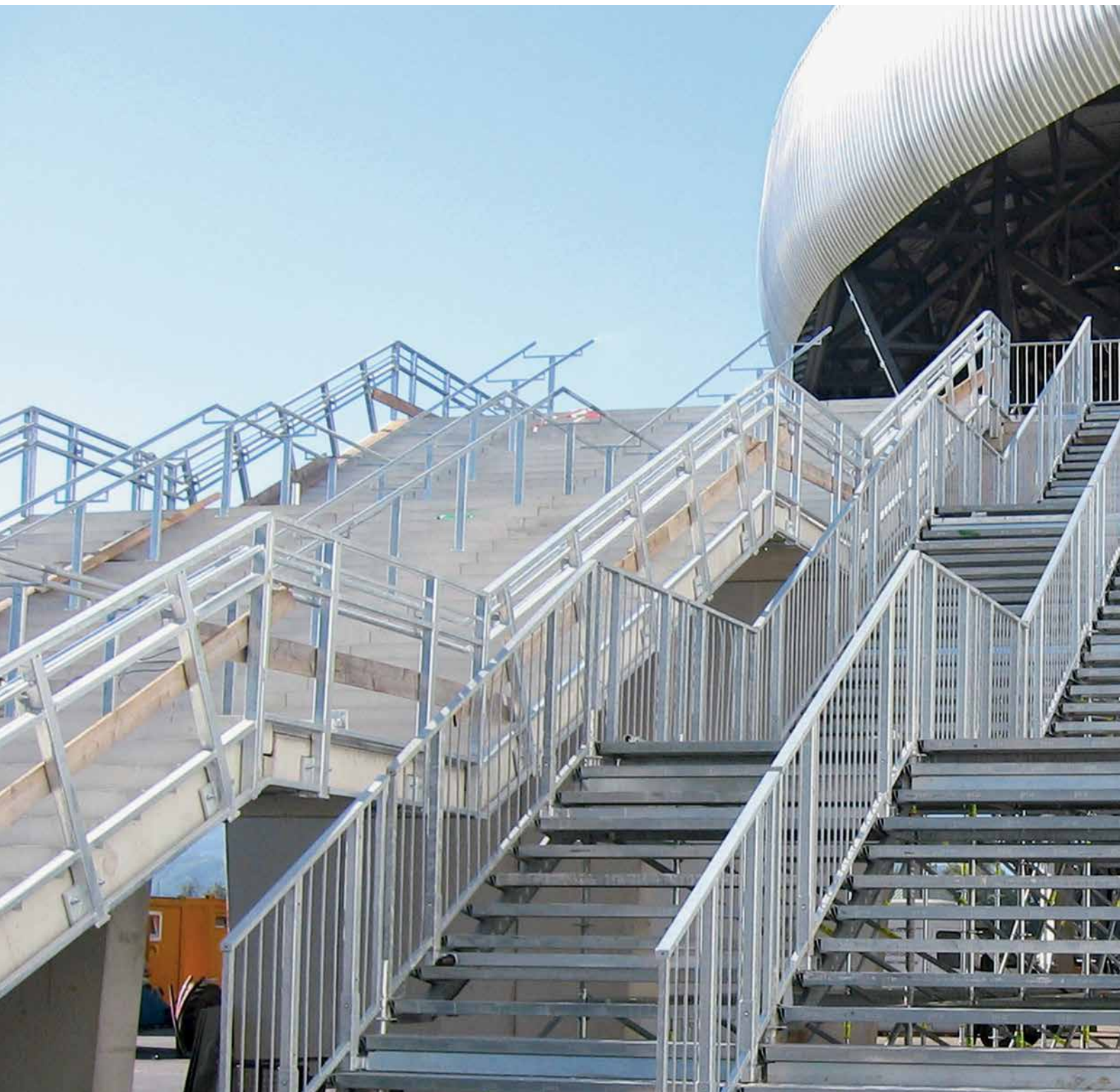

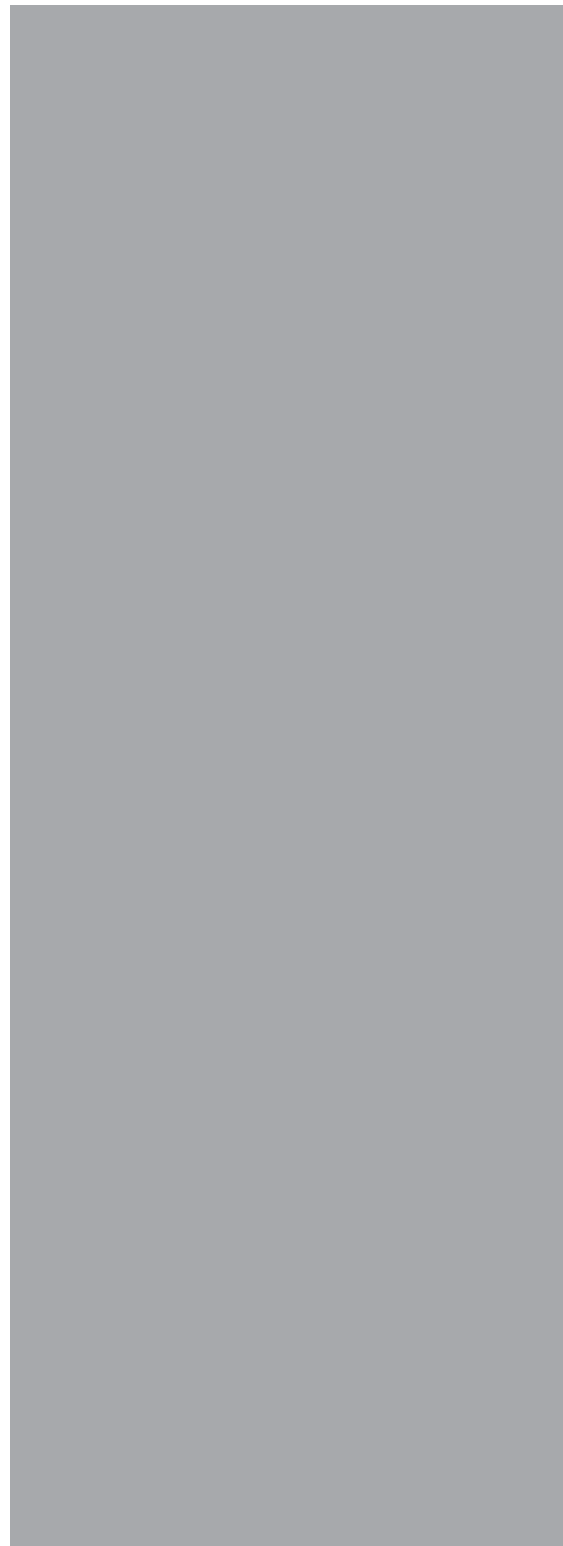

Overview of access means

Continuous and dog-legged staircases as well as stair towers

Single width and linked continuous staircases

→ see page 40

PERI UP Rosett Stair Public 150, 200 and 250

e.g. single continuous staircase, 200 cm wide

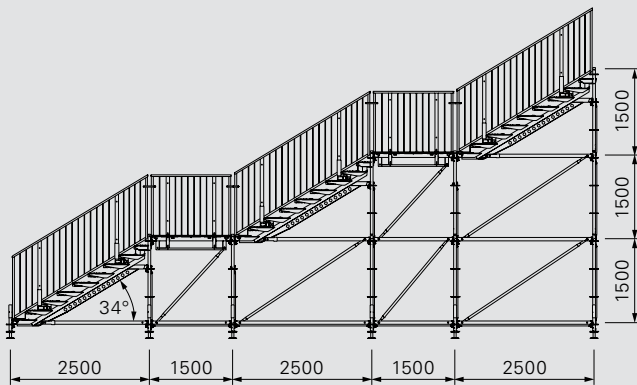

Staircase units in the same direction

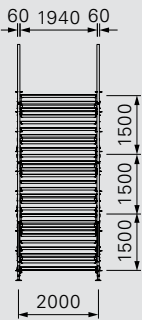

Possible flight widths:
150 cm, 200 cm, 250 cm

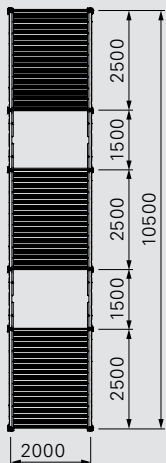

e.g. triple bank of continuous staircases, 600 cm wide

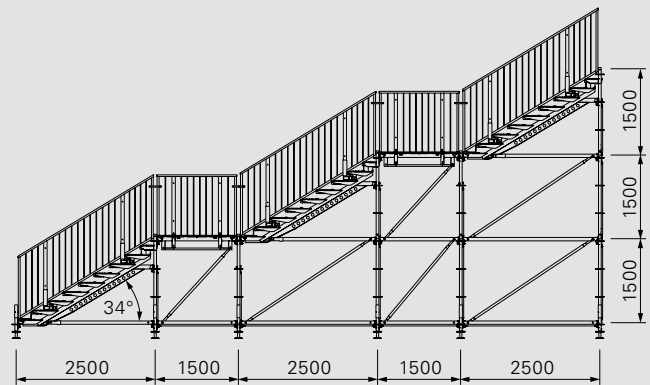

Staircase units in the same direction

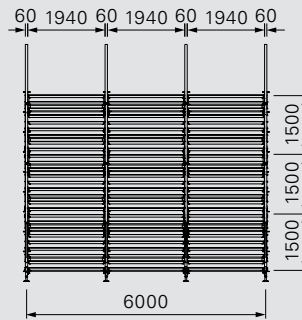

Possible flight widths:
150 cm, 200 cm, 250 cm

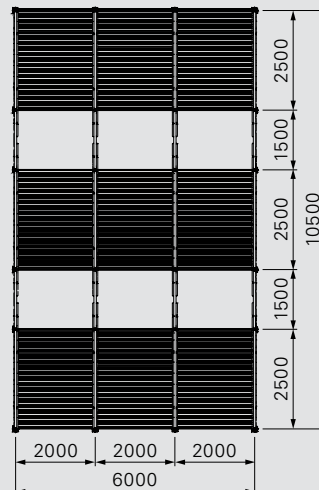

Dog-legged staircases and stair towers

→ see page 46

PERI UP Rosett Stair Public 150

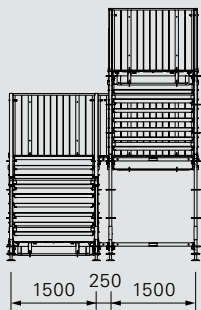

Possible flight width: 150 cm

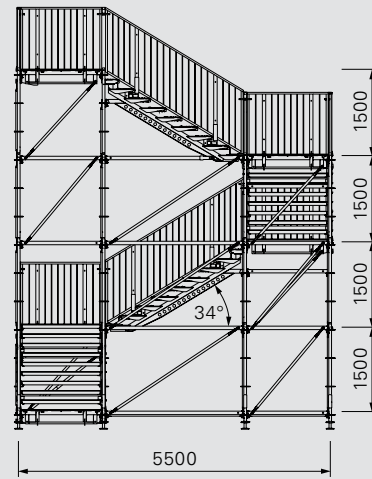

Possible flight width: 150 cm

Examples of possible ground plans:

Dog-legged flights of stairs

Stair tower without stair well

Stair tower with square-shaped ground plan

Stair tower with rectangular ground plan

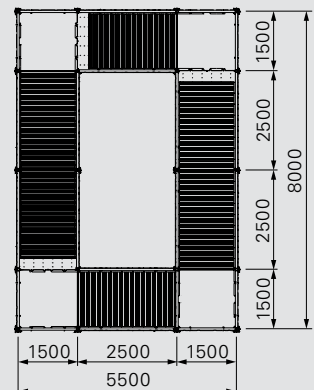
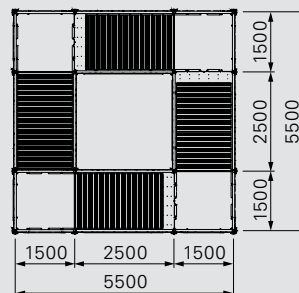
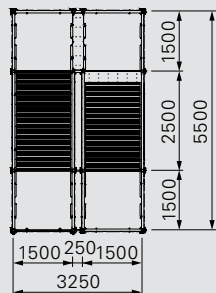
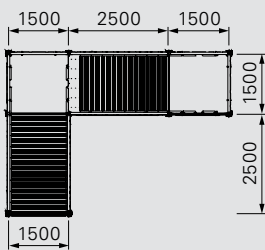

PERI UP Rosett Stair Public

Single width continuous staircases as escape or emergency stairs



For stairs used in public areas, special attention is paid for ensuring the safety of the users. For stairs used in public areas, special attention is paid to providing complete safety for the users. Existing regulations are frequently tightened through additional requirements. PERI UP Rosett Stair Public corresponds to all the latest requirements and is used to realize a wide range of structures using very few individual components.

PERI UP Rosett Stair Public has been designed for live loads of up to 7.5 kN/m², and the guardrails for loads of up to 2.0 kN/m meet the highest

safety requirements. In addition, geometrical requirements regarding the rise/tread ratio, safety barriers and climbing over guardrails are fulfilled as well as being vandalism-proof to a very high level.

The system has been optimized for use with public stairs thanks to landings completely covered with decking. The decks are completely closed and protect workers on all levels against dirt and water falling from higher levels.

Typical applications are as access to grandstands, to temporary pedestrian bridges or as a replacement for indoor and outdoor stairs during refurbishment.

Single width continuous staircase 250 cm wide. The landings are installed after 18 steps.



With the integrated lock against lift off, the UDS Deck is immediately secured after being placed in position and moved sideways; the securing hook engages the ledger by sliding forward the decking.

Assembly of the PERI UP Rosett Stair Public

1. Mount the stair stringer on the scaffold sub-construction.
2. Fix the stringer frame for the guardrails.
3. Install the steel decking.
4. Insert the guardrails which simultaneously secure the decking against removal.

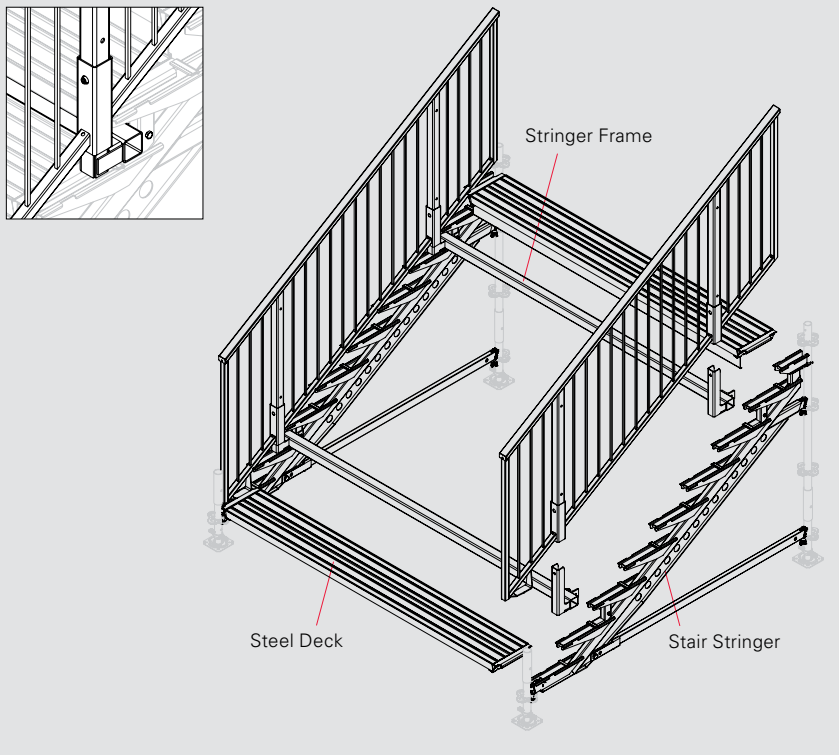

PERI UP Public can also be used for small heights of 150 cm and more. There is a choice of widths – 150 cm, 200 cm or 250 cm – with a depth of 250 cm.

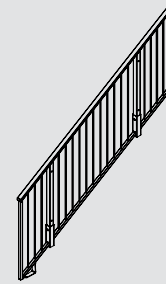
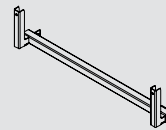
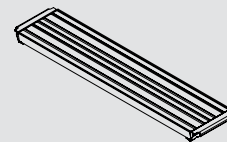
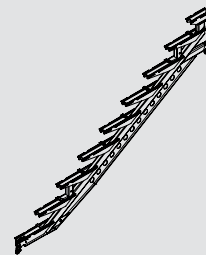
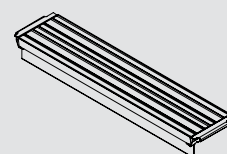
**PERI UP Rosett Scaffold System****Stair Guardrail UZG 250/150**
Stringer Frame UZF 150
Stringer Frame UZF 200
Stringer Frame UZF 250

Steel Deck UDS 32 x 150
Steel Deck UDS 32 x 200
Steel Deck UDS 32 x 250
**Stair Stringer UZS 250/150**
Steel Deck UDS 32 x 150 Public
Steel Deck UDS 32 x 200 Public
Steel Deck UDS 32 x 250 Public

PERI UP Rosett Stair Public

Linked continuous staircases e.g. for separate directions



Solution for a trade fair: stairway leading to a pedestrian bridge over a multi-lane road with separate routes for up and down.



Entry to the railway platforms via temporary stairways and a temporary pedestrian bridge made it possible to separate the construction site for the new accesses of public traffic to the platforms.

With the stair stringers of the PERI UP Rosett Staircase Public, steel decks can be installed on the left and right of the stringers. In doing so, any required width for the bank of continuous staircases can be assembled whereby the width of each individual flight of stairs can be freely chosen.

150 cm, 200 cm and 250 cm widths are available which fulfil the clear mini-

mum width requirements of 120 cm, 180 cm or 240 cm for public stairs in each case. The flights of stairs provide safe accessibility due to guardrails on both sides and separate large crowds into smaller and manageable groups.

The directions can be specified thus contributing to very effective use of the stairs by large crowds of people, e.g. at trade fairs.

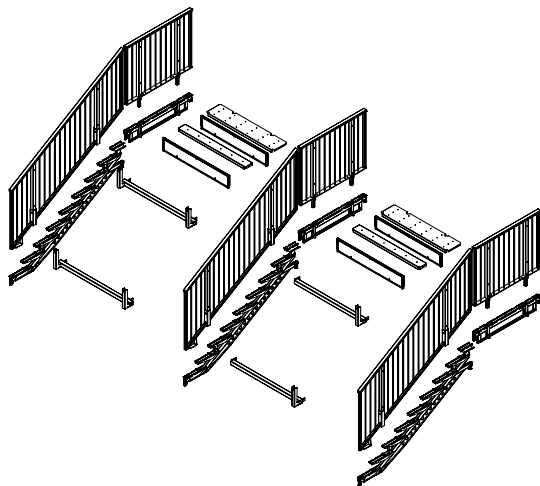

Wide, linked continuous staircases are created through additions on both sides of the stair stringer with the same components as for single continuous staircases.



Due to the intermediate guardrails, the stairs and landings are safe to use, also with wide banks of continuous staircases.



The steel decks for the steps are secured via bolted guardrails which prevents them from being removed.

PERI UP Rosett Scaffold System

Stair Guardrail UZG 150

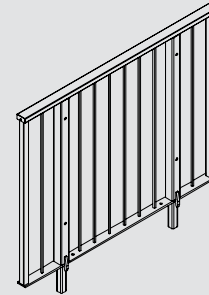

Landing Transom UZL 150

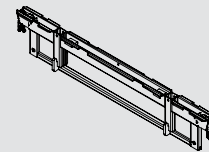

- Gap Filler UZD 150 x 16
- Gap Filler UZD 200 x 16
- Gap Filler UZD 250 x 16

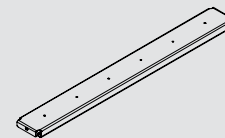

- Stringer Frame UZF 150
- Stringer Frame UZF 200
- Stringer Frame UZF 250

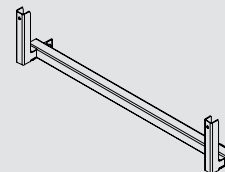

- End Guardrail Post UZE 150
- End Guardrail Post UZE 200
- End Guardrail Post UZE 250

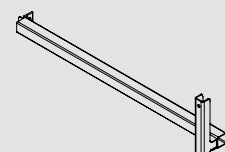

PERI UP Rosett Stair Public

Bank of continuous staircases of different widths complete with static proof

Especially at major events such as sports championships and concerts, additional access routes for pedestrians must be available for ensuring safe and effective crowd management for short periods at a time. Stairs are required in particular for entering and leaving halls, stadiums or parking facilities. The PERI UP Rosett Staircase Public offers a solution for every requirement.

Regardless whether it is wide stairways or small, separate entrances for reporters or athletes, the stairs can be adjusted for almost any loads, geometry and number of users.





Bank of continuous staircases for the refurbishment of a football stadium. This bank of continuous staircases was needed for the football matches at weekends and was moved by crane to a storage area during the week to allow construction work to continue.

PERI UP Rosett Scaffold System

Stair Guardrail UZG 150

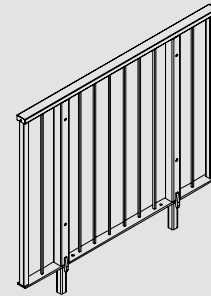

Steel Deck UDS 32 x 150
Steel Deck UDS 32 x 200
Steel Deck UDS 32 x 250

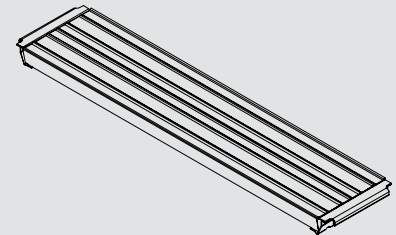

Steel Deck UDS 32 x 150 Public
Steel Deck UDS 32 x 200 Public
Steel Deck UDS 32 x 250 Public

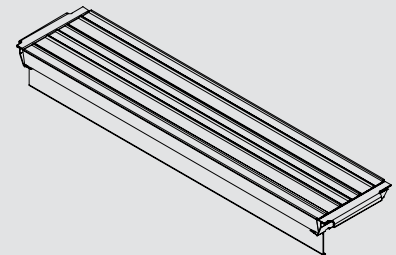

Gap Filler UZD 150 x 16
Gap Filler UZD 200 x 16
Gap Filler UZD 250 x 16

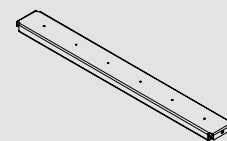

PERI UP Rosett Stair Public

Dog-legged staircases

PERI UP Rosett Stair Public serves as a temporary escape route during construction work in the inside of a building – with the highest requirements regarding safety and load bearing capacity.



On every 150 cm wide landing, the direction of the staircase can be changed by 90° or 180°. This results in dog-legged staircases which are used, for example, for accessing stages with entrances and exits on both sides.

The transition between two guardrails is realised by means of guardrail connectors which are arranged in a straight line or over the corner into which a guardrail filler can also be installed.

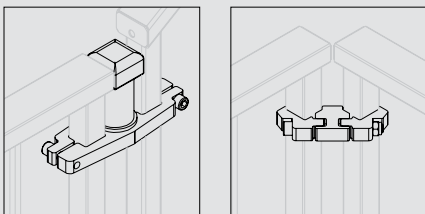

In order to ensure that fingers are not trapped, the connectors prevent various movements of the guardrails between the transition areas.

Formation of a landing for a stair angle of 90 degrees.

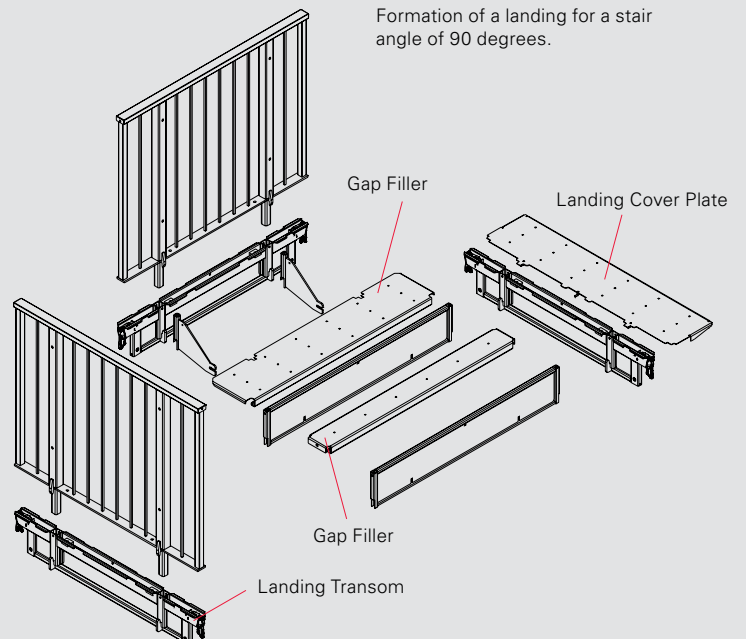



PERI UP Rosett Scaffold System

Guardrail Filler

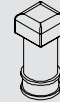

Guardrail Connector, Straight

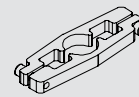

Guardrail Connector, Corner



Stair Guardrail UZG 150

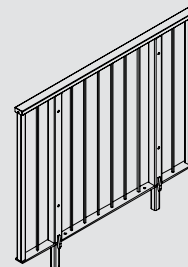

Gap Filler UZD 150 x 31

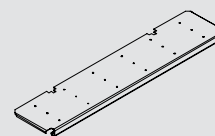

Steel Deck UDS 32 x 150

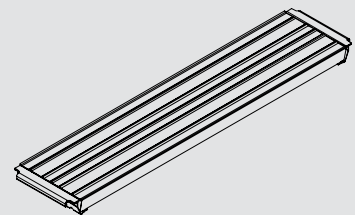

Landing Cover Plate UZD 150/25



PERI UP Rosett Stair Public

Stair towers with and without stairwells

Stair tower inside a church which serves as an emergency stairway in case the electrically-operated elevator breaks down.



Stair towers with PERI UP Rosett Stair Public can be adapted to existing ground plans. This results in minimum dimensions of 3.25 m x 5.50 m.

Depending upon customer requirements and structural conditions – and on the basis of the minimum dimen-

sions – other geometries can be selected for the stair tower by changing the lengths of the staircase units. In this way, stair towers are formed around a stair well. For standard live loads, stair towers can be erected up to heights of 24 m. Depending on the country and application, live loads range between 3.5 kN/m² and 7.5 kN/m².

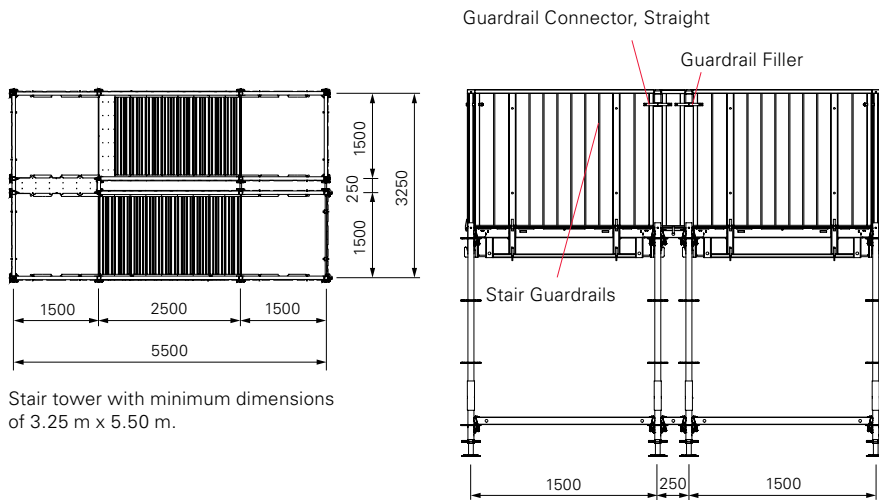

Stair tower with minimum dimensions of 3.25 m x 5.50 m.

Stair tower erected around a stairwell With ground plan dimensions of 5.50 m x 8.00 m. In the longer direction, two staircase units with altogether 18 steps are arranged one behind the other.

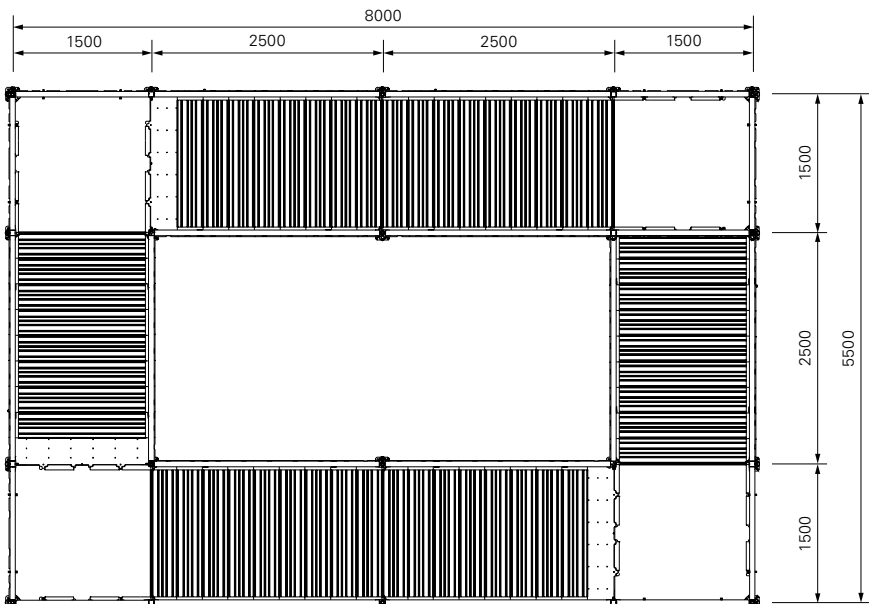

PERI UP Rosett Scaffold System

Standard UVR 300 Public



Stair Guardrail UZG 150

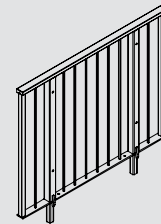

Guardrail Frame UZG 25



Stair Stringer UZS 250/150

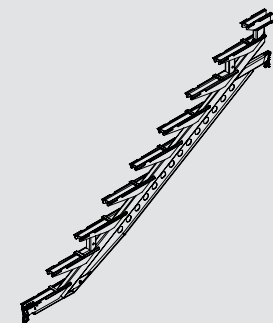

H-Ledger with Lap UHP 200

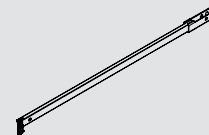

PERI UP access technology

at a glance

Means of access for construction sites and industry									
Details		Hatches		Access Decks			Access Deck	Access Deck with Ladder	
		UAF 50 x 75	UAF 75 x 100	UAL-3 75 x 150/3	UAL-3 75 x 200/3	UAL-3 75 x 250/3	EAW 200	EAW-L 250	EAW-L 300
		PERI UP Flex Modular Scaffolding (Deck UDG)					PERI UP Easy Frame Scaffolding (Deck EDS)		
Loads									
Dead weight /Deck	kg	9.33	15.7	15.6	19.6	23.5	18.7	26.2	29.5
Dead weight/m Height	kg/m	–	–	43 - 50	45 - 52	47 - 55	42 - 49	46 - 54	49 - 56
Live load per flight of stairs	kN/m ²	2.00 (=LC3)		2.00 (=LC3)			2.00 (=LC3)	2.00 (=LC3)	
Live load on a complete construction	kN/m ²	2.00		2.00	2.00	2.00	2.00	2.00	
max. possible number of persons	–	1	2	2	3	4	3	4	5
Geometry									
Ladder: inclined	Degrees	68	68	70	70	70	70	70	70
Ladder: length	cm	217	217	209	209	209	209	209	209
Ladder: rung spacing	cm	28	28	28	28	28	28	28	28
Ladder: width	cm	35	35	35	35	35	35	35	35
Level height between decking	cm	200	200	200	200	200	200	200	200
Clear headroom	cm	193	193	193	193	193	193	193	193
Guardrail heights	cm	100 ± 5	100 ± 5	100 ± 5	100 ± 5	100 ± 5	100 ± 5	100 ± 5	100 ± 5
Clear distance between guardrails	cm	≤ 47	≤ 47	≤ 47	≤ 47	≤ 47	≤ 47	≤ 47	≤ 47
Number of legs	–	4	4	4	4	4	4	4	4
Ground plan dimensions W x L	m x m	75 x L L ≤ 300	75 x L L ≤ 300	75 x 150 100 x 150	75 x 200 100 x 200	75 x 250 100 x 250	67 x 200 100 x 200	67 x 250 100 x 250	67 x 300 100 x 300
max. distance to wall	cm	10 to 80 see working scaffold							
max. height of standard configuration	m	–	–	24	24	24	24	24	24
max. height (project-related)	m	100	100	100	100	90	100	90	80
Equipment variations									
unclad	–	yes	yes	yes	yes	yes	yes	yes	yes
with netting	–	yes	yes	yes	yes	yes	yes	yes	yes
with tarpaulin	–	yes	yes	yes	yes	yes	yes	yes	yes
Anchoring									
Anchor spacing/No. of anchors	–	see anchor arrangement of working scaffold							
Instructions for Assembly and Use	–	available	available	available	available	available	available	available	available
Standards / Regulations									
Germany	–	DIN EN 12811-1		DIN EN 12811-1			DIN EN 12811-1	DIN EN 12811-1	
Europe	–	e.g. F: NF EN 12811-1 GB: BSI EN 12811-1							
World	–	–	–	–	–	–	–	–	–

		Means of access for construction sites and industry			Access in public areas	
Details		Staircases up to 2.0 kN/m ²	Staircases up to 3.0 kN/m ²		Staircases for 3.5 to 7.5 kN/m ²	
		Staircase 75	Staircase 100	Staircase 125	Stair Public 150	Stair Public 200 Stair Public 250
		PERI UP Flex Modular Scaffolding (Deck UDG)			PERI UP Rosett Scaffold System (Deck UDS)	
Loads						
Dead Weight/Staircase	kg	Length 250: 28.1 Length 300: 33.1	Step 100: 7.4 Step 125: 9.3 Stair Stringer: 15.3		Steel Deck 150: 11.2 Steel Deck 250: 17.0 Stair Stringer: 42.8	
Dead weight/m Height	kg/m	82 – 117	205	230	> 360	
Live load per flight of stairs	kN/m ²	2.00	3.00		3.50 – 7.50	
Live load on a complete construction	kN	26.60	40.00		complete stairs including all landings	
max. possible number of persons	–	15 - 20	40		up to 10 persons/m ²	
Geometry						
Inclination of stairs	Degrees	48	39	39	34	34
clear step width	cm	67	100	125	150	200. 250
Step depth/height	cm/cm	15/ 20	29/ 20	29/ 20	32/ 17	32/ 17
Staircase unit width	cm	71	100	125	150	200. 250
Floor height per staircase unit	cm	200	200	200	150	150
Clear headroom	cm	193	193 + 243	193 + 243	294	294
Guardrail heights	cm	100 ± 5	100 ± 5	100 ± 5	110	110
Clear distance between guardrails	cm	≤ 47	≤ 47	≤ 47	vertical ties every 10 cm	
Number of legs	–	4	10		Stair tower: 16 otherwise: dependent on stair geometry	
Ground plan dimensions W x L	m x m	150 x 250 150 x 300	200 x 450 200 x 550	250 x 500 250 x 550	≥ 325 x 550	dependent on stair geometry
max. distance to wall	cm	≤ 30 > 30 verification required	≤ 200		project-specific verification required	
max. height of standard configuration	m	66	50	40	12	dependent on staircase unit width and load
max. height (project-related)	m	90	80	70	30	
Equipment variations						
unclad	–	yes	yes	yes	yes	yes
with netting	–	not in standard configuration, project-specific verification required			not in standard configuration, project-specific verification required	
with tarpaulin	–	not in standard configuration, project-specific verification required			not in standard configuration, project-specific verification required	
Anchoring						
Anchor spacing/No. of anchors (height examples)	–	H = 14 m: 2 H = 30 m: 5	H = 14 m: 2 H = 30 m: 4		H = 6 m: 3 H = 12 m: 7	
Instructions for Assembly and Use	–	available	available		available	
Standards / Regulations						
Germany	–	DIN EN 12811-1			DIN EN 13814, State Building Codes, Regulations on Places of Assembly	
Europe	–	e.g. F: NF P 93-522 GB: BSI EN 12811-1			A: ÖNORM EN 13814 F: NF EN 13814 I: UNI EN 13814	
World	–	–			e.g. from UEFA, FIFA Olympic Committee	

**The optimal System
for every Project and
every Requirement**



Wall Formwork



Column Formwork



Slab Formwork



Climbing Systems



Bridge Formwork



Tunnel Formwork



Shoring Systems



Construction Scaffold



Facade Scaffold



Industrial Scaffold



Access



Protection Scaffold



Safety Systems



System-Independent Accessories



Services



PERI GmbH
Formwork Scaffolding Engineering
 Rudolf-Diesel-Strasse 19
 89264 Weissenhorn
 Germany
 Tel. +49 (0)7309.950-0
 Fax +49 (0)7309.951-0
 info@peri.com
 www.peri.com