

# Box-Out Formwork

The dimensionally stable and lightweight Door and VARIO Box-Out Formwork

Product Brochure – Issue 01/2021

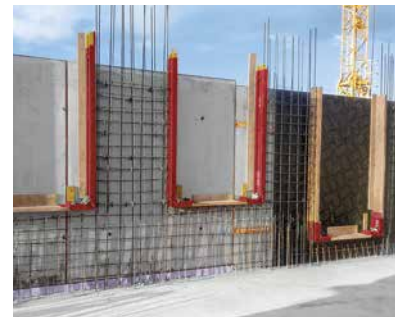
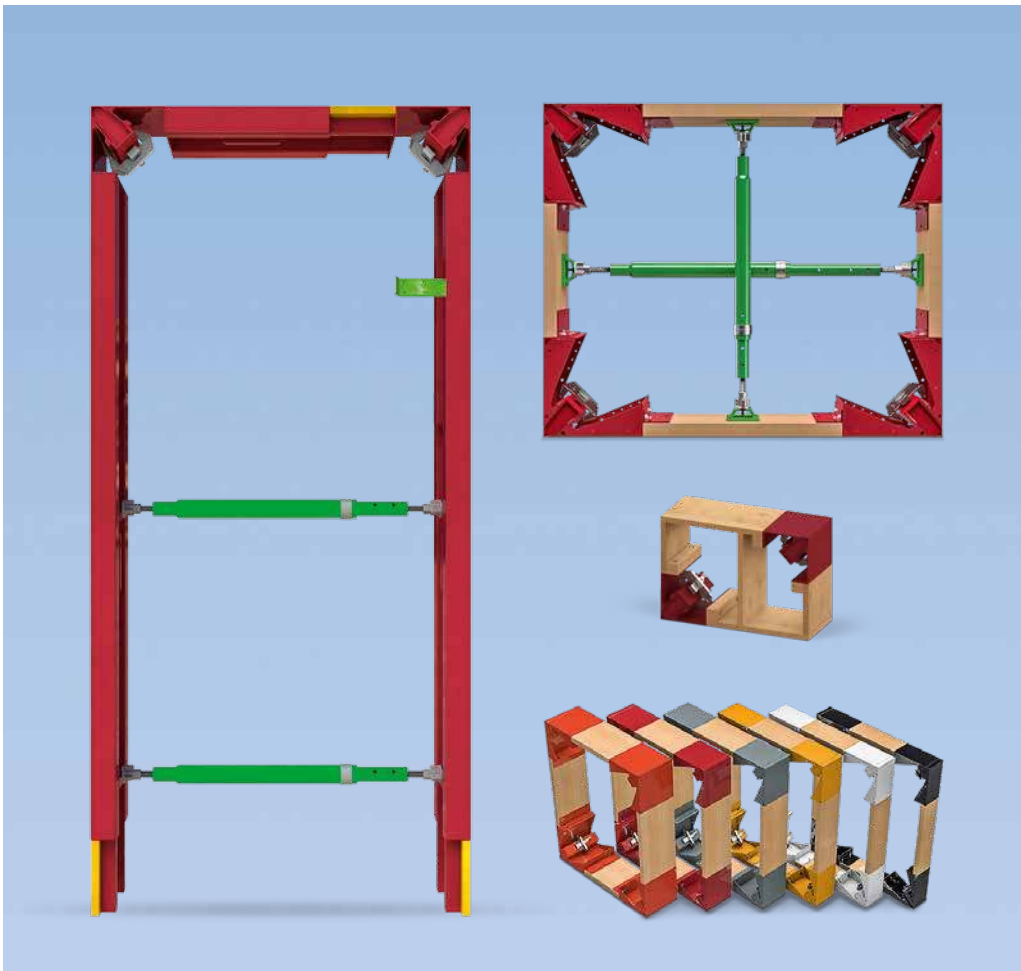

# Content

## System Advantages

- 6 Cost-effective forming**
- 7 Highest product quality**
- 8 Flexible recess sizes**

## System Overview

- 10 Box-Out Formwork for doors at a glance**
- 12 VARIO Box-Out Formwork for windows and small recesses at a glance**

**Issue 10/2019**

### **Publisher**

**PERI AG**  
**Formwork Scaffolding Engineering**  
Rudolf-Diesel-Strasse 19  
89264 Weissenhorn  
Germany  
info@peri.com  
www.peri.com

## Programme Overview

### 14 Programme overview: individual elements

### 15 Programme overview: sets

#### Important Information

All current safety regulations and guidelines applicable in those countries where our products are used must be observed.

The photos shown in this brochure feature construction sites in progress. For this reason, safety and anchor details in particular cannot always be considered as conclusive or final. These are subject to the risk assessment carried out by the contractor.

In addition, computer graphics are used which are to be understood as system representations. To ensure a better understanding, these and the detailed illustrations shown have been partially

reduced to show certain aspects. The safety installations which have possibly not been shown in these detailed descriptions must nevertheless still be available. Please note that the systems or items shown might not be available in every country.

Safety instructions and load specifications are to be strictly observed at all times. Separate structural calculations are required for any deviations from the standard design data.

The information contained herein is subject to technical changes in the interests of progress. Errors and typographical mistakes reserved.



## Box-Out Formwork for door and window openings

The modular design principle for doors and windows

**The re-usable Box-Out Formwork facilitates fast shuttering and striking operations for doors, windows and small recesses. Simple assembly, a high degree of flexibility as well as dimensionally precise results ensure cost savings and consistent quality.**

The Box-Out Formwork for doors, windows and smaller recesses not only reduces personnel and material requirements on the construction site, but also the time required.

Innovative system corner components thus ensure easy and fast striking. In addition, only a minimum of components are required for the assembly process, which can be successfully carried out without any errors after a short briefing.

Furthermore, the formwork elements are characterised by their particularly lightweight design. Thanks to the

aluminium components and the high-quality powder coating, the Box-Out Formwork can be frequently re-used.

Different formwork elements facilitate the use of a wide range of door and window sizes. Thus, the door height can be extended from 200 to 250 cm and the door widths flexibly adjusted depending on the requirements.

In addition, recesses between 75 and 300 cm wide can be struck in walls and slabs, e.g. windows. For this, formlining between 21 and 55 mm can be used whereby tool-free adjustments on the construction site are possible.



### Cost-effective forming

through simple and fast assembly operations directly on site with reduced material requirements and labour cost savings of up to 80 per cent.



### Highest product quality

and a long service life due to the powder coating, as well as consistent formwork results with every application.



### Flexible recess sizes

due to the tool-free adjustment range of the formlining thickness, variable leg lengths and adjustable widths.

## Cost-effective forming

Fast working and reduced material requirements thanks to re-usable Box-Out Formwork

**The Box-Out Formwork saves valuable time and money on the construction site. In contrast to self-made individual solutions, it can be re-used multiple times. Assembly can be carried out quickly and easily after a short briefing – without requiring any special tools.**

Working time on the construction site and, thus, labour costs can be reduced by up to 80 per cent by using Box-Out Formwork. In addition, due to the low total weight, the Box-Out Formwork elements are particularly easy to transport. This also accelerates work processes on the construction site. Furthermore, savings can be made on materials because hardly any formworking timber is required when using the Box-Out Formwork. This also benefits the environment.

The clearly marked forming components along with the different colours used simplify the assembly process.



The welded carrying handles ensure optimal handling on the construction site. The Fixing Aid is used for attaching to the setting formwork.



The patented system corner components facilitate easy and quick shuttering and striking in less than 10 minutes.



The Multi-Struts have been designed to accommodate tensile and compressive forces and to ensure a secure connection of the formwork elements.

## Highest product quality

Lightweight, powder-coated aluminium formwork elements ensure dimensionally accurate results



The Box-Out Formwork ensures dimensionally accurate results when striking doors and windows

**The Box-Out Formwork ensures extremely accurate results with every application and, thus, stands for the highest possible quality. This is also backed up by the long service life of the product.**

Due to the high-quality processing, the Box-Out Formwork can frequently be re-used. The aluminium components and powder coating ensure a dimensionally stable and extremely light product. The result: right-angled and perpendicular reveals.



Handling the Box-Out Formwork is very efficient and easy thanks to the Strut Couplers.



The Formwork Clamp firmly and reliably connects the forming components and system corner parts - a well-proven closing system.



The lightweight aluminium components with high-quality powder coating ensure right-angled and perpendicular reveals.

## Flexible recess sizes

Fast striking of different widths and heights for a range of wall thicknesses

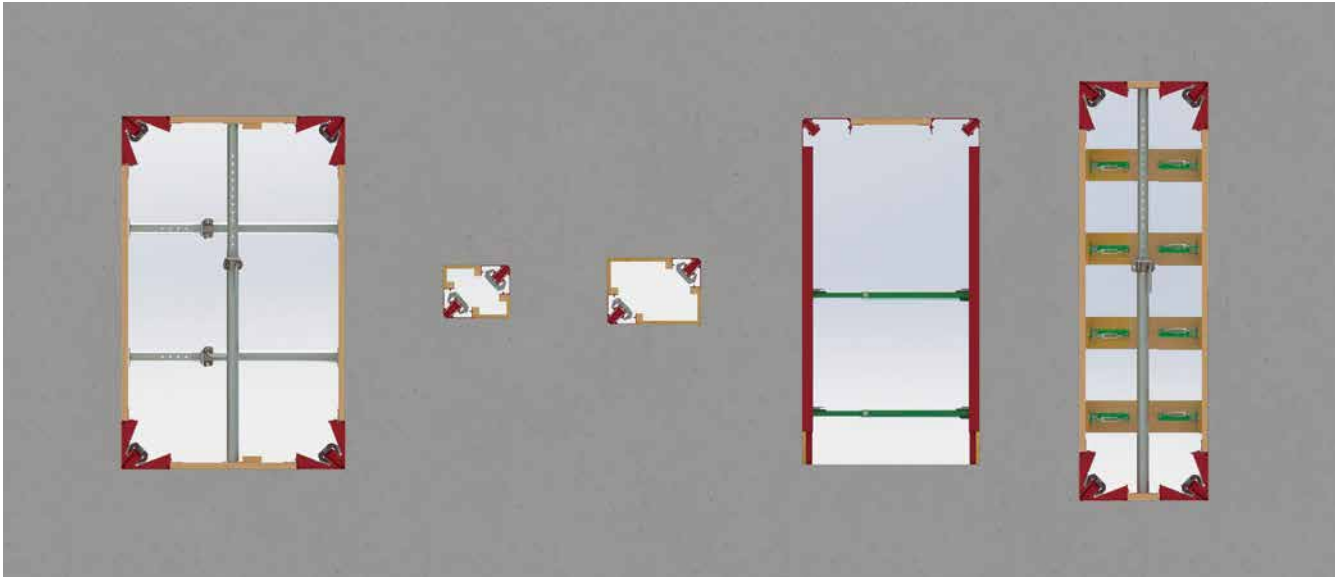

**The Box-Out Formwork can be combined with any panel formwork system. Thanks to its suitability for accommodating different wall thicknesses, widths and heights, it can be used extremely flexibly.**

It is suitable for wall thicknesses of 15, 18, 20, 24, 25 and 30 cm. In the process, different colours provide a quick overview of the respective wall thickness. Thanks to the telescoping possibility, the door height can be flexibly adjusted from 200 to 250 cm. Door widths between 88.5 and 200 cm can be struck using the Multi Element, whilst the VARIO Element allows for completely flexible width adjustment.

The striking of VARIO Box-Out openings is possible from 75 to 300 cm; In the case of wider openings, tube filling can also be carried out. Thereby, the formlining thickness can be adjusted between 21 and 55 mm without requiring any tools. Any residual length compensation can easily be realised using multi-layer panels, formwork panels or planks.



Box-Out Formwork for wall thicknesses of 20, 24, 25 and 30 cm are characterised by the use of different colours.

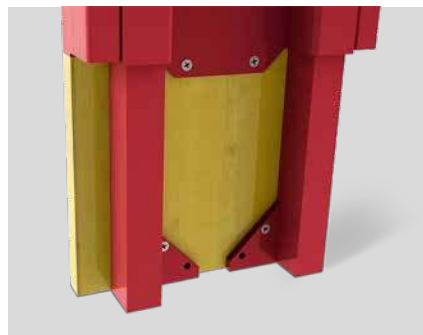

Thanks to the telescoping possibility, door heights of 200 to 250 cm can be struck.



With the Multi and the VARIO Elements, it is possible to carry out a range of door and window width adjustments.



# Box-out formwork for doors at a glance

**VARIO Element VE**



**Multi Element ME**



**Formwork Clamp**

**Door Former Element SE**  
made of high load-bearing aluminium and suitable for a range of wall thicknesses

**Multi Strut MS**

**Corner Wedge SEK**  
facilitates fast and simple striking

**Fixing Aid FX**

**Carrying Handle**

**Strut Coupler KP**

**Telescoping**

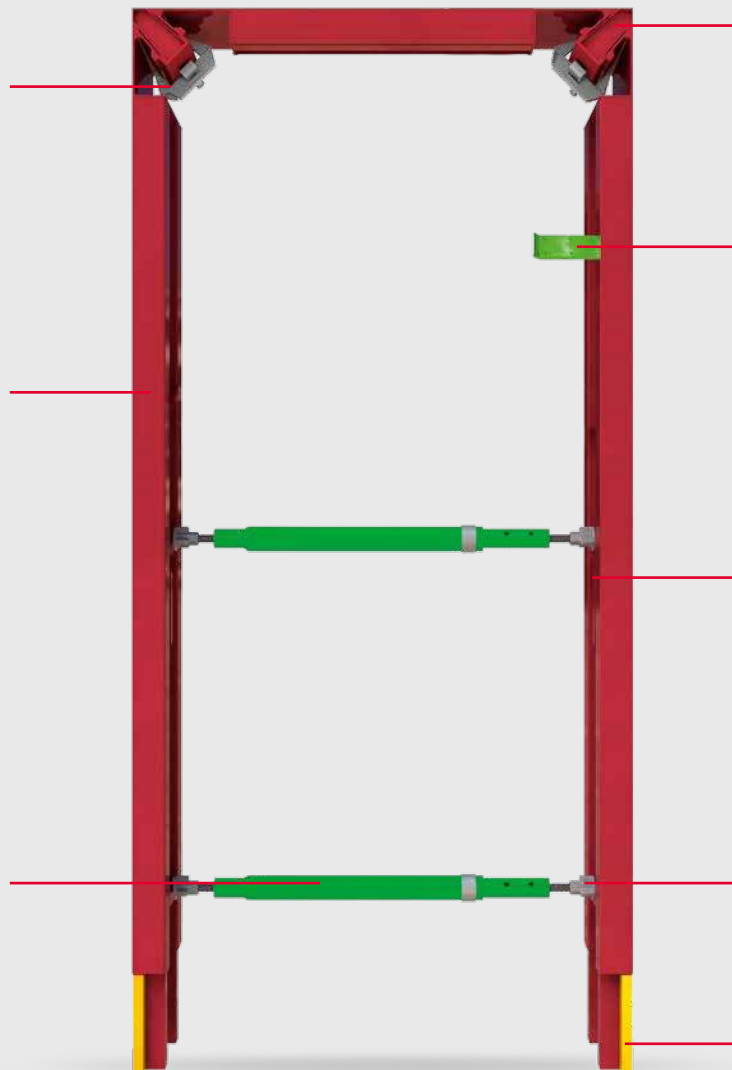

is suitable for all door widths as well as recesses in walls and decks from 75 to 300 cm wide. The formlining thickness can be adjusted between 21 and 55 mm without requiring any tools.

can be adjusted precisely and flexibly to accommodate door widths from

- with 20 cm, 24 cm, 25 cm elements: 88,5 cm to 190 cm
- with 30 cm element: 101 cm to 200 cm

All three elements are marked in different colours to facilitate fast wall thickness identification and are thereby suitable for the following wall thicknesses:

- 30 cm
- 25 cm
- 24 cm
- 20 cm



#### Multi Strut MS

available in the following options: MS-130 (88.5 - 130 cm lengths), MS-190 (130 - 190 cm lengths) and MS-300 (190 - 300 cm lengths) to ensure a secure hold and connection of the formwork elements

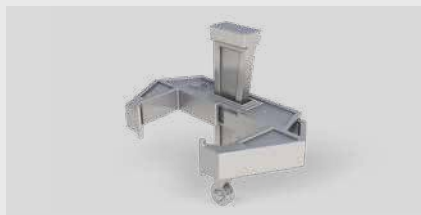

#### Formwork Clamp

firmly and reliably connects the forming components and system corner parts



#### Fixing Aid FX

serves to attach the door formwork to the setting formwork



#### Carrying Handle

for optimal and safe handling of the formwork elements.



#### Strut Coupler KP

for quick and easy attachment of the Multi Struts to the formwork element

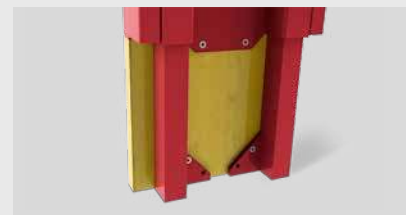

#### Telescoping

for flexible adjustment of the door height between 200 and 250 cm



#### Nailing Strip for wall thickness element for 30 cm

for optimal and safe handling of the formwork elements

- Easy mounting and higher strength due to the integrated nailing strip
- Simple screw connection for individual wall thicknesses

## VARIO Box-out Formwork for windows and small recesses at a glance

### VARIO and Mini VARIO Elements

#### VARIO Element VE

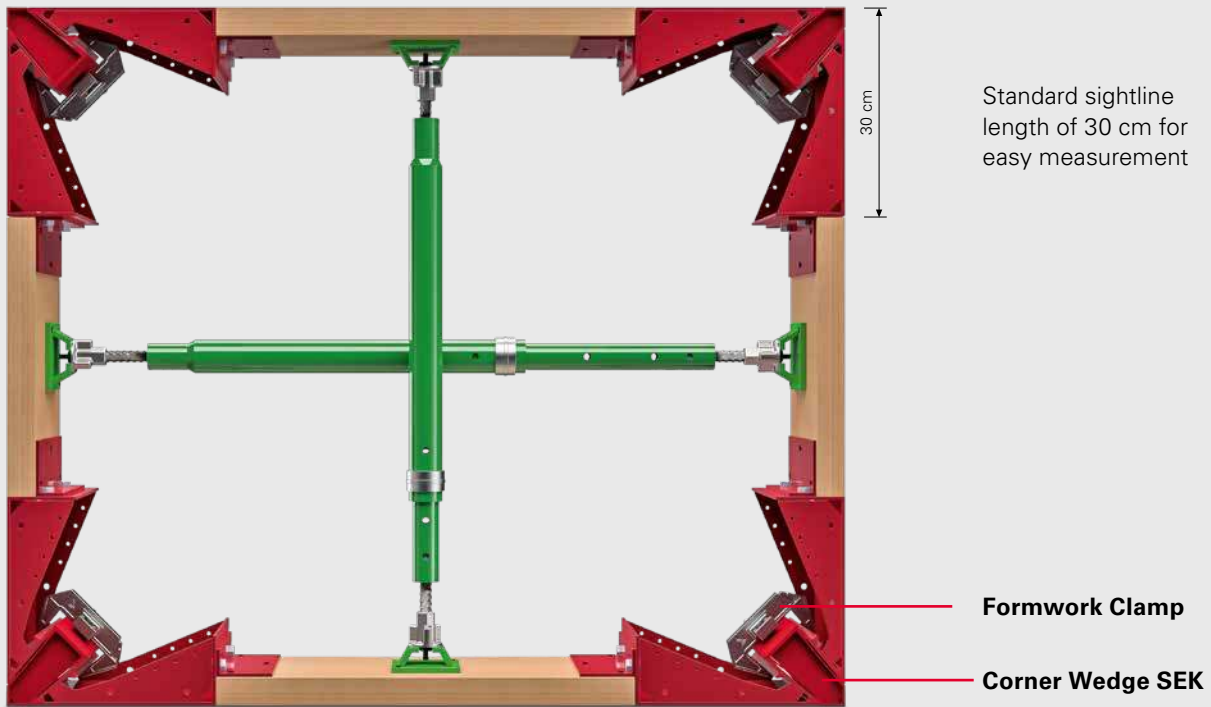

The VARIO Element VE is suitable for recesses in walls and slabs from 75 to 300 cm wide, as well as for door recesses of any width. The formlining thickness can be adjusted between 21 and 55 mm without requiring any tools.

For fast wall thickness identification, the Corner Wedges SEK are marked in different colours. Thereby, the VARIO Box-Out Formwork with diagonal struts is suitable for the following wall thicknesses:

- 30 cm
- 25 cm
- 24 cm
- 20 cm
- 18 cm
- 15 cm

## VARIO Element VE



### Nailing Strip for all VARIO Elements VE

for optimal and safe handling of the formwork elements

- Easy mounting and higher strength due to the integrated nailing strip
- Simple screw connection for individual wall thicknesses (e.g. 2 x 20 cm elements for 40 cm wall thickness)

Adjustabil formlining thickness

Nailing Strip

## Mini VARIO Element MVE

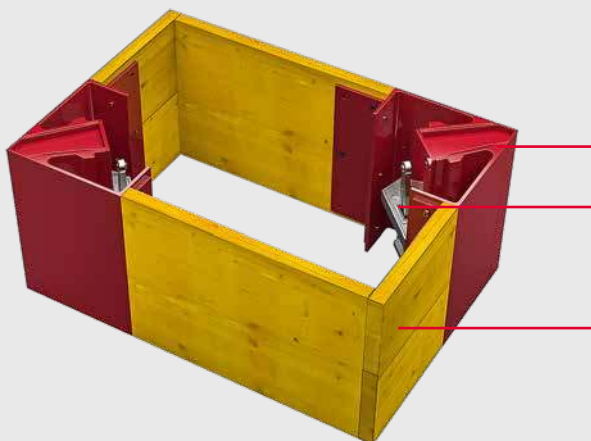

Corner Wedge SEK





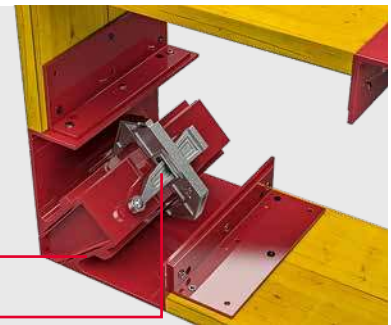



Formwork Clamp

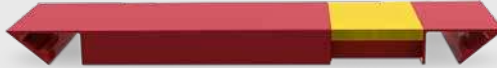

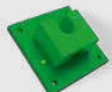

Fix wood thickness 21 mm



The Mini VARIO Element MVE is suitable for openings from 28 to 300 cm. The Corner Wedges SEK are marked in different colours and are therefore suitable for the following wall thicknesses:

- |         |         |
|---------|---------|
| ■ 30 cm | ■ 20 cm |
| ■ 25 cm | ■ 18 cm |
| ■ 24 cm | ■ 15 cm |

Item no.	Weight kg	Designation	
033226	10,98	Door Former Element SE20	
033227	14,10	Door Former Element SE24	
033228	16,13	Door Former Element SE25	
033229	19,50	Door Former Element SE30	
033246	5,44	Multi Element ME 20-126	
033247	6,72	Multi Element ME 24-126	
033248	7,10	Multi Element ME 25-126	
033249	8,59	Multi Element ME 30-140	
033250	8,42	Multi Element ME 20-190	
033251	10,14	Multi Element ME 24-190	
033252	10,97	Multi Element ME 25-190	
033253	13,27	Multi Element ME 30-200	
033348	0,91	VARIO Corner Element VE 15	
033350	1,09	VARIO Corner Element VE 18	
033254	2,26	VARIO Corner Element VE 20	
033255	2,62	VARIO Corner Element VE 24	
033256	2,70	VARIO Corner Element VE 25	
033257	3,16	VARIO Corner Element VE 30	
033351	0,91	Mini VARIO Corner Element MVE 15	
033352	1,09	Mini VARIO Corner Element MVE 18	
033258	1,16	Mini VARIO Corner Element MVE 20	
033259	1,38	Mini VARIO Corner Element MVE 24	
033260	1,40	Mini VARIO Corner Element MVE 25	
033261	1,82	Mini VARIO Corner Element MVE 30	
033262	2,91	Multi Strut MS 89	
033263	3,22	Multi Strut MS 130	
033264	4,32	Multi Strut MS 190	
033265	6,12	Multi Strut MS 300	
033266	0,40	Strut Coupler	
033267	0,62	Strut Coupler Rotate	
033347	0,52	Corner Wedge SEK 15	
033349	0,61	Corner Wedge SEK 18	
033268	0,68	Corner Wedge SEK 20	
033269	0,84	Corner Wedge SEK 24	
033270	0,86	Corner Wedge SEK 25	
033271	1,02	Corner Wedge SEK 30	
033272	0,82	Formwork Clamp	
033273	0,42	Fixing Aid FX58 WS 20/24/25	

Item no.	Weight kg	Designation	Content	
033282	30,40	Door Formwork Set Multi W20-126	2x033226, 1x033246, 2x033272, 2x033268	
033283	33,38	Door Formwork Set Multi W20-190	2x033226, 1x033250, 2x033272, 2x033268	
033291	38,24	Door Formwork Set Multi W24-126	2x033227, 1x033247, 2x033272, 2x033269	
033292	41,66	Door Formwork Set Multi W24-190	2x033227, 1x033251, 2x033272, 2x033269	
033300	42,72	Door Formwork Set Multi W25-126	2x033228, 1x033248, 2x033272, 2x033270	
033301	46,59	Door Formwork Set Multi W25-190	2x033228, 1x033252, 2x033272, 2x033270	
033309	51,45	Door Formwork Set Multi W30-140	2x033229, 1x033249, 2x033272, 2x033271	
033310	56,14	Door Formwork Set Multi W30-200	2x033229, 1x033253, 2x033272, 2x033271	
033284	29,48	Door Formwork Set VARIO W20	2x033226, 2x033254, 2x033272, 2x033268	
033293	36,76	Door Formwork Set VARIO W24	2x033227, 2x033255, 2x033272, 2x033269	
033302	41,02	Door Formwork Set VARIO W25	2x033228, 2x033256, 2x033272, 2x033270	
033311	49,63	Door Formwork Set VARIO W30	2x033229, 2x033257, 2x033272, 2x033271	
033353	19,28	VARIO Box-Out Set W15	8x033348, 4x033272, 4x033347	
033355	22,48	VARIO Box-Out Set W18	8x033350, 4x033272, 4x033349	
033285	24,80	VARIO Box-Out Set W20	8x033254, 4x033272, 4x033268	
033294	27,60	VARIO Box-Out Set W24	8x033255, 4x033272, 4x033269	
033303	28,32	VARIO Box-Out Set W25	8x033256, 4x033272, 4x033270	
033312	32,64	VARIO Box-Out Set W30	8x033257, 4x033272, 4x033271	
033354	12,68	VARIO Box-Out Set Mini W15	8x033351, 4x033272, 4x033347	
033356	14,56	VARIO Box-Out Set Mini W18	8x033352, 4x033272, 4x033349	
033286	15,28	VARIO Box-Out Set Mini W20	8x033258, 4x033272, 4x033268	
033295	17,68	VARIO Box-Out Set Mini W24	8x033259, 4x033272, 4x033269	
033304	17,92	VARIO Box-Out Set Mini W25	8x033260, 4x033272, 4x033270	
033313	20,96	VARIO Box-Out Set Mini W30	8x033261, 4x033272, 4x033271	

**The optimal System  
for every Project and  
every Requirement**



**Wall Formwork**



**Column Formwork**



**Slab Formwork**



**Climbing Systems**



**Bridge Formwork**



**Tunnel Formwork**



**Shoring Systems**



**Construction Scaffold**



**Facade Scaffold**



**Industrial Scaffold**



**Access**



**Protection Scaffold**



**Safety Systems**



**System-Independent  
Accessories**



**Services**



PERIDK  
Forskalling Stillads Rådgivning  
Greve Main 26  
2670 Greve  
Danmark  
Telefon +45 43453627  
peri@peri.dk  
www.peri.dk

